

Mata le Chéile

TÚS MAITH

Florence Gavin

Micheál Ó Fathaigh a d'aistrigh

 AN GÚM

Baile Átha Cliath

An leagan Béarla
Ba iad Mulberry Publications a chéadfhoilsigh faoin teideal *Maths Together: Start-Ups*
© Florence Gavin, 1999

An leagan Gaeilge
© Foras na Gaeilge, 2002
ISBN 1-85791-448-1

Gach ceart ar cosaint. Ní ceadmhach aon chuid den fhoilseachán seo a atáirgeadh,
gan cead a fháil roimh ré ón bhfoilsitheoir.

Tá cead ón bhfoilsitheoir ag múinteoirí, áfach, fótachóipeanna a dhéanamh
de leathanaigh lena n-úsáid sa seomra ranga.

Is le caoinchead Chomhlacht Oideachais na hÉireann
atá an rann ar leathanach 9-7 á athfhoilsiú anseo.

Mulberry Publications Teo. a chuir suas an cló

Criterion Press Teo. a chlóbhuail in Éirinn

Le fáil ar an bpost uathu seo:

An Siopa Leabhar,
6 Sráid Fhearchair,
Baile Átha Cliath 2.
ansiopaleabhar@eircom.net

nó

An Ceathrú Póilí,
Cultúrlann Mac Adam–Ó Fiaich,
216 Bóthar na bhFál,
Béal Feirste BT12 6AH.
acpoili@mail.portland.co.uk

Orduithe ó leabhardhioltóirí chuig:

Áis,
31 Sráid na bhFíníní,
Baile Átha Cliath 2.
eolas@forasnagaeilge.ie

An Gúm, 24-27 Sráid Fhreidric Thuaidh, Baile Átha Cliath 1

Clár an Ábhair

Naíonáin Sóisir

Caibidil	Snáithe	Snáithaonad
1	Luathghníomhaíochtaí matamaiticiúla	Meaitseáil; Rangú; Comparáid a dhéanamh
2	Luathghníomhaíochtaí matamaiticiúla; Uimhreas	Cur in Ord; Comhaireamh; Uimhriú
3	Luathghníomhaíochtaí matamaiticiúla; Uimhreas	Cur in Ord; Comhaireamh; Uimhriú
4	Luathghníomhaíochtaí matamaiticiúla; Uimhreas	Meaitseáil; Comparáid a dhéanamh
5	Uimhreas	Cónascadh; Comparáid a dhéanamh

Naíonáin Sinsir

Caibidil	Snáithe	Snáithaonad
6	Uimhreas; Ailgéabar	Comhaireamh; Comparáid a dhéanamh; Uimhriú; Patrúin a fhorleathnú; Cónascadh
7	Uimhreas	Cónascadh; Roinnt; Comparáid a dhéanamh
8	Uimhreas	Comhaireamh; Comparáid a dhéanamh; Cónascadh
9	Uimhreas; Cruth & Spás; Tomhais	Comhaireamh; Cur in Ord; Feasacht Spáis; Am, Meáchan, Airgead; Comparáid a dhéanamh; Cruthanna tríthoiseacha

Cártaí Teanga

Eangach le haghaidh Ciúib

Gníomhaíocht	Snáithe	Caibidil	Leathanaigh
Meaitseáil	Luathghníomhaíochtaí matamaiticiúla	1	1, 2, 3, 4, 5, 6, 7, 8, 9, 10
Meaitseáil	Luathghníomhaíochtaí matamaiticiúla	3	3, 10, 11, 12, 19
Meaitseáil	Luathghníomhaíochtaí matamaiticiúla	4	3, 6, 11
Meaitseáil	Luathghníomhaíochtaí matamaiticiúla	6	1
Tacair	Luathghníomhaíochtaí matamaiticiúla	1	12, 13, 14, 15, 16, 17
Tacair	Luathghníomhaíochtaí matamaiticiúla	2	18, 19, 20, 21
Tacair	Luathghníomhaíochtaí matamaiticiúla	3	4, 14
Comhfhreagras aon le haon	Luathghníomhaíochtaí matamaiticiúla	1	18, 19, 20, 21, 22, 23, 24
Comhfhreagras aon le haon	Luathghníomhaíochtaí matamaiticiúla	2	1, 2, 3, 4, 5, 6
Comhfhreagras aon le haon	Luathghníomhaíochtaí matamaiticiúla	3	2
Comhfhreagras aon le haon	Luathghníomhaíochtaí matamaiticiúla	9	18
Comhaireamh	Uimhreas	2	7, 8, 9, 10, 11, 12, 13, 14, 14, 16
Comhaireamh	Uimhreas	2	22, 23, 24
Comhaireamh	Uimhreas	3	5, 22, 23
Comhaireamh	Uimhreas	4	9
Comhaireamh	Uimhreas	5	3, 4
Comhaireamh	Uimhreas	6	13, 14, 15, 16 17
Comhaireamh	Uimhreas	7	8, 9, 10, 11, 14, 23, 24, 25, 26
Comhaireamh	Uimhreas	8	6, 7, 8, 9, 15, 16, 18, 19, 21, 22, 23, 24, 25
Comhaireamh	Uimhreas	9	2, 3, 4, 5, 6, 17, 21
Comhaireamh	Cruth & Spás	6	2, 3, 4, 5, 6, 7
Uimhriú	Uimhreas	2	17
Uimhriú	Uimhreas	3	6, 7, 8, 9, 13, 15, 16, 17, 18, 20, 21
Uimhriú Cruth & Spás	Uimhreas Cruth & Spás	3	24

Gníomhaíocht	Snáithe	Caibidil	Leathanaigh
Rangú	Luathghníomhaíochtaí matamaiticiúla	4	2, 4, 5, 10
Rangú	Luathghníomhaíochtaí matamaiticiúla	5	2, 15, 16
Rangú	Luathghníomhaíochtaí matamaiticiúla	6	8, 9, 10, 11
Rangú	Luathghníomhaíochtaí matamaiticiúla	7	13
Rangú	Luathghníomhaíochtaí matamaiticiúla	8	13
Patrúin	Ailgéabar	4	12, 13, 14
Anailís Uimhris	Uimhreas	5	5, 6, 7, 8, 9, 10, 11, 12, 13, 14, 15
Anailís Uimhris	Uimhreas	7	15, 17
Anailís Uimhris	Uimhreas	8	4, 13
Anailís Uimhris	Uimhreas	9	8, 14, 20
Cónascadh	Uimhreas	6	18, 19, 20, 21, 22, 23, 24, 25, 26
Cónascadh	Uimhreas	7	3, 4, 5, 6, 7, 18, 19
Cónascadh	Uimhreas	8	5
Cruthanna	Cruth & Spás	7	1, 20, 21
Cruthanna	Cruth & Spás	8	1
Cruthanna	Cruth & Spás	9	11, 12
Comparáid	Tomhais	8	2, 3, 11, 12
Comparáid	Uimhreas	9	22
Leithead	Tomhais	9	9, 26
Airde	Tomhais	8	17
Ord uimhreacha	Uimhreas	9	1
Orduimhreacha	Uimhreas	9	2
Am / Meáchan / Toilleadh	Tomhais	9	22, 24, 25
Comhtháthú	Uimhreas, Cruth & Spás	7	2, 20, 21
Comhtháthú	Teanga	7	12, 16, 22
Meastachán / Nascadh	Fadhbanna Focal	9	10
Comhtháthú	Teanga	8	14
Comhtháthú	Teanga	9	7

Réamhrá

Pacáiste oibre i gcomhair na Matamaitice i mblianta tosaigh na scolaíochta is ea *Mata le Chéile: Tús Maith*. Ar ranganna na Naíonán Sóisir agus na Naíonán Sinsir atá sé dírithe. Tá stór cuimsitheach gníomhaíochtaí ar fáil ar na bileoga oibre agus ar na cártaí teanga chun dul i ngleic leis na príomhchoincheapa agus leis na scileanna atá curaclam nua na Matamaitice ag iarraidh a fhorbairt sa bhunscoil. Is féidir leas a bhaint as an bpacáiste le dul ag obair leis an rang iomlán, le grúpaí daltaí nó le daltaí aonair. Tá cead ag an múinteoir na bileoga oibre a chóipeáil agus a dháileadh lena n-úsáid sa seomra ranga. Is féidir na cártaí teanga a ghearradh agus leas a bhaint astu le plé ar choincheapa na Matamaitice a spreagadh.

Tá *Mata le Chéile: Tús Maith* ag teacht leis an gcur cuige comhtháite is fearr a oireann do dhaltaí óga, agus a bhfuil cuntas air in *Curaclam na Bunscoile: Matamaitic* (An Roinn Oideachais agus Eolaíochta, 1999). Tá sé shnáithe i gcuraclam na Matamaitice ar an leibhéal seo:

- Luathghníomhaíochtaí matamaiticiúla
- Uimhreas
- Ailgéabar
- Cruth agus Spás
- Tomhais
- Sonraí

‘Déanann na snáitheanna mogalra d’aonaid ghaolmhara idirspleácha. ... Ní aonad scartha é aon snáithe díobh’ (*Treoirlínte do Mhúinteoirí, lch 8*).

Sa súgradh a leagtar síos bunchloch na forbartha ag páistí. Is próiseas nádúrtha foghlama é an súgradh. Tá an lán gníomhaíochtaí matamaiticiúla nár mhiste do dhaltaí taithí phraiticiúil a fháil orthu ina gcuid súgartha, idir shaorshúgradh agus shúgradh faoi threoir, sula dtugann siad aghaidh orthu sa leabhar seo. Agus iad ag foghlaim na Matamaitice ní mór do dhaltaí a bheith ag obair le nithe a aithníonn agus a thuigeann siad, agus a mbíonn spéis acu féin iontu.

Cuirtear béim mhór sa churaclam ar fhorbairt theanga na Matamaitice. Is ceart don mhúinteoir a bheith de shíor ag plé an ábhair leis na daltaí de réir mar a dhéanann siad na gníomhaíochtaí atá in *Mata le Chéile: Tús Maith* – meaitseáil, sórtáil, rangú, péireáil, cur rudaí i gcomparáid le chéile agus in ord, comhaireamh. Ar an gcaoi sin feicfidh an múinteoir cén fhorbairt a bheidh ag teacht ar an tabhairt faoi deara ag na daltaí, ar theanga na Matamaitice acu agus ar a gcumas réasúnaíochta i gcomhthéacs na Matamaitice. Ós féidir leathanaigh *Mata le Chéile: Tús Maith* a chóipeáil is féidir leis na daltaí na gníomhaíochtaí éagsúla a chleachtadh agus a athcheachtadh chomh minic agus is gá chun cur lena gcuid eolais agus lena bhfeinmhuinín. Ní mór don mhúinteoir gach ceacht nua a chónascadh lenar fhoghlaim na daltaí cheana, agus le hábhair eile ar an gcuraclam nuair is féidir sin.

Bíonn tuiscint mhaith ag daltaí áirithe ar an Matamaitic faoin am a dtosaíonn siad ar an scoil. Bíonn obair dhúshlánach ag teastáil ó na daltaí sin. Ní hamhlaidh a bhíonn gach dalta chomh heolach céanna i dtús a chuid scolaíochta, áfach. Lena chois sin, bíonn gach dalta ag foghlaim ar a ráta pearsanta féin. An tréimhse a bheidh le caitheamh ar gach snáithe nó ar gach snáithaonad, beidh sí ag brath ar dhul chun cinn an dalta aonair. Oireann *Mata le Chéile: Tús Maith* don chur chuige solúbtha sin. Tá a lán léaráidí sa leabhar agus, leis an mbéim sa leabhar ar theanga na Matamaitice, daingneofar an méid a fhoghlaimoidh na daltaí sna gníomhaíochtaí praiticiúla.

Tá sé thar a bheith tábhachtach go bhfaigheadh na daltaí tuiscint agus máistreacht ar na luathghníomhaíochtaí agus ar na bunchoincheapa Matamaitice a chuirtear ina láthair in *Mata le Chéile: Tús Maith*. Is é cuspóir an leabhair tús maith a chur ar an bhfoghlaim agus cur le féinmhuinín na ndaltaí.

Florence Gavin
Iúil 2002

Naíonáin Sóisir

Meaitseáil iad seo.

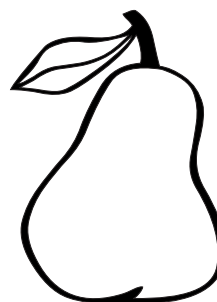
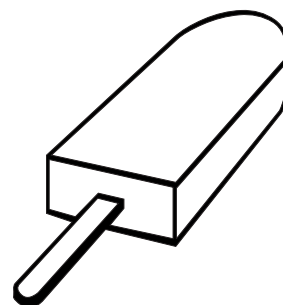
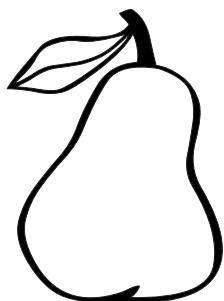
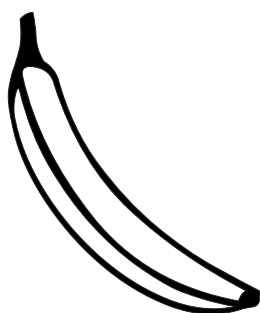
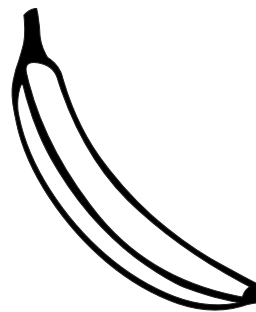
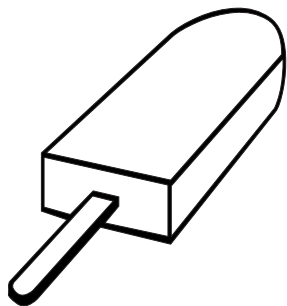

Meaitseáil iad seo.

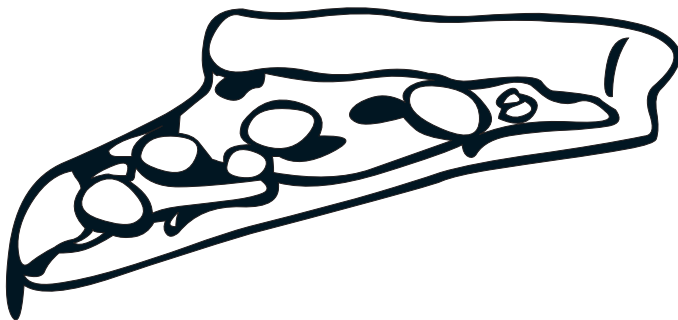
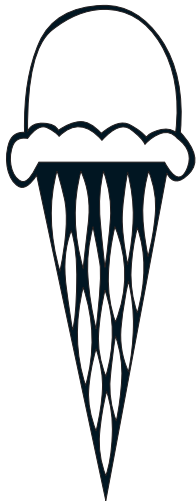
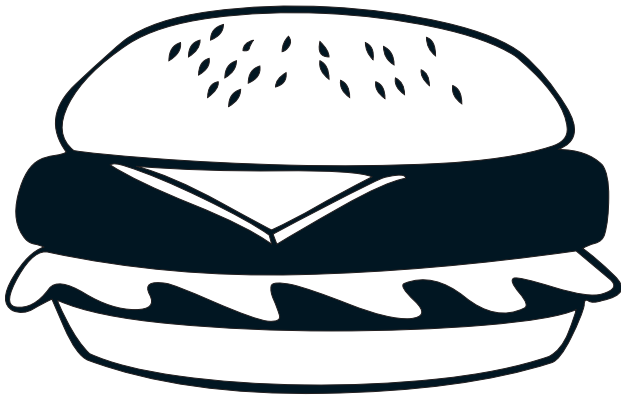
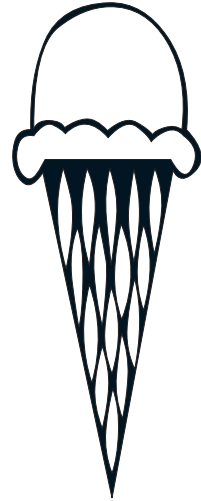

Meaitseáil iad seo.

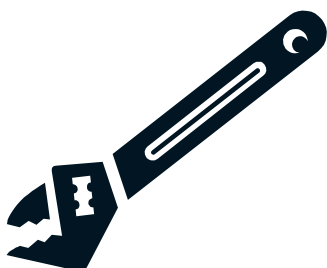
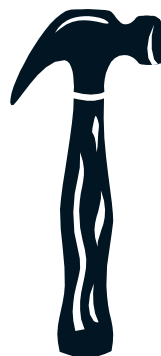
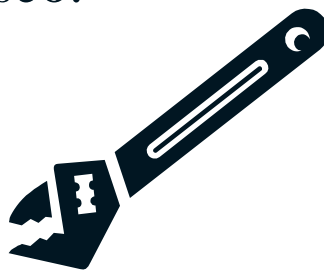
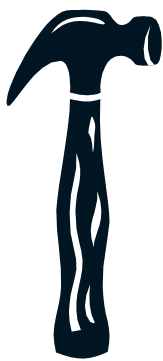

Meitseáil iad seo.

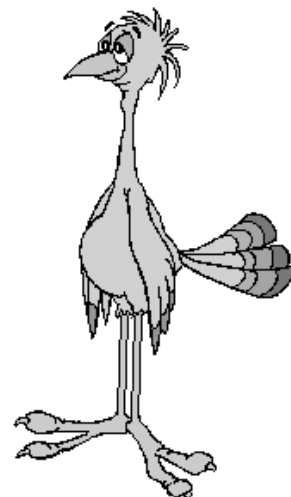
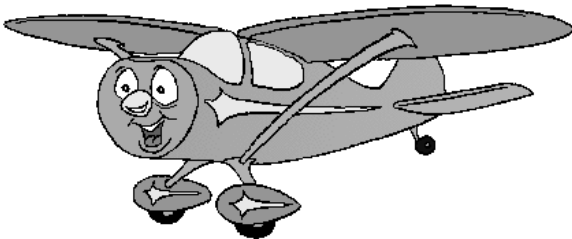
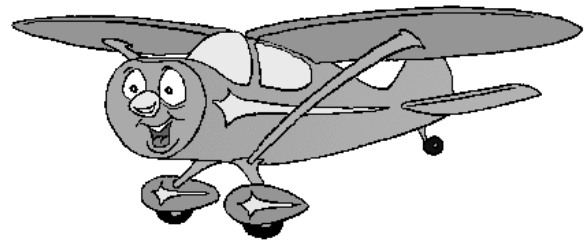
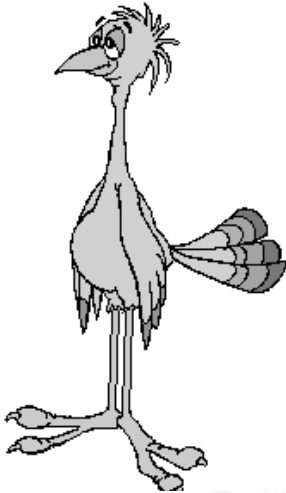
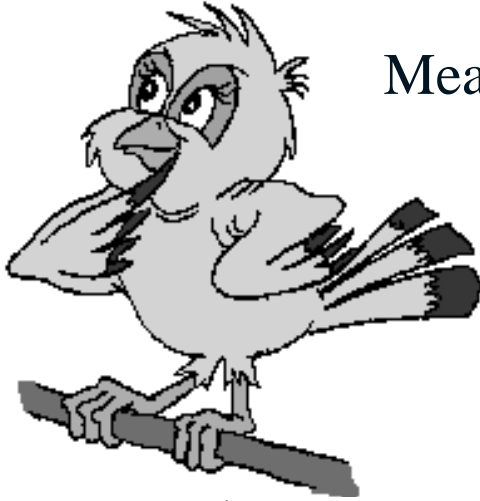

Meaitseáil iad seo.

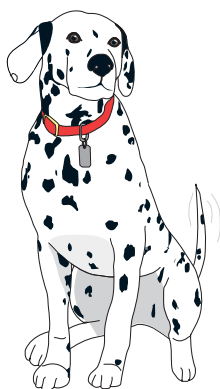

Meaitseáil iad seo.

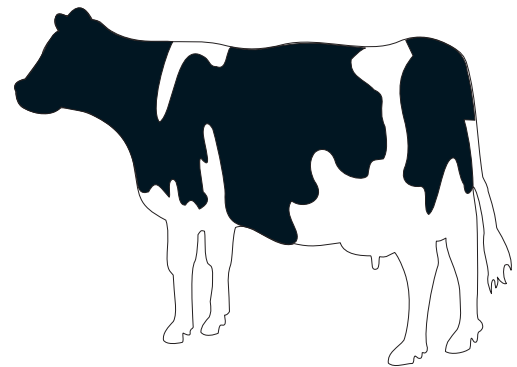
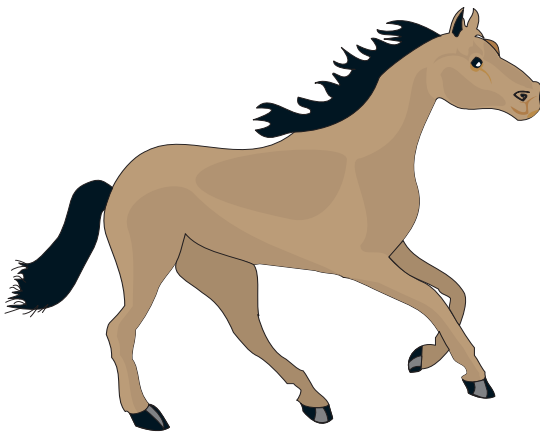
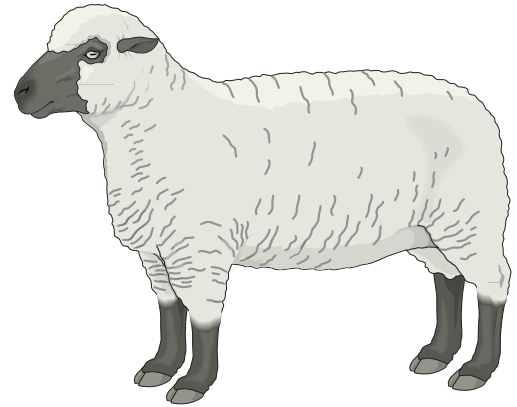
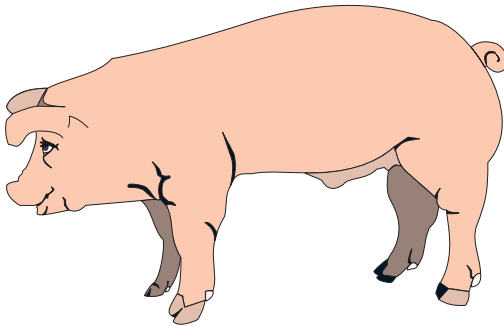
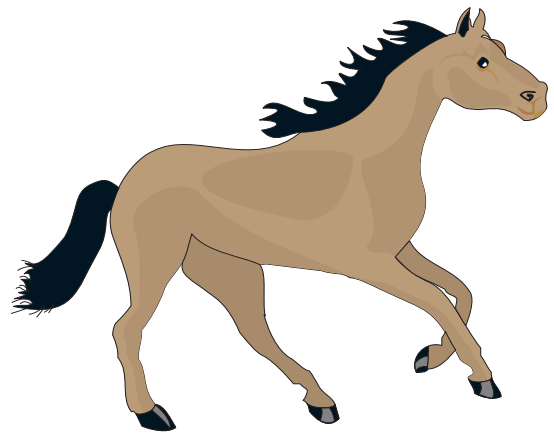
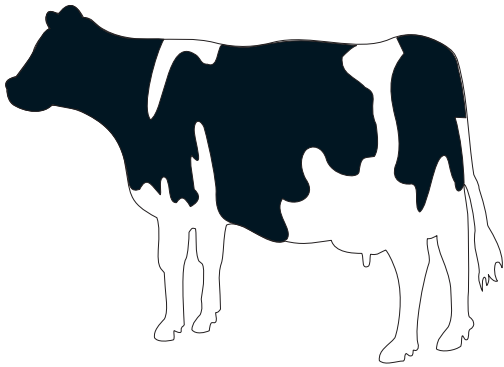
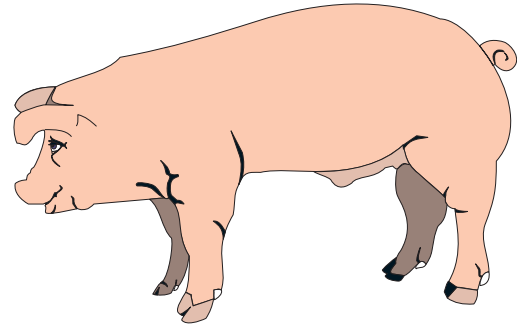
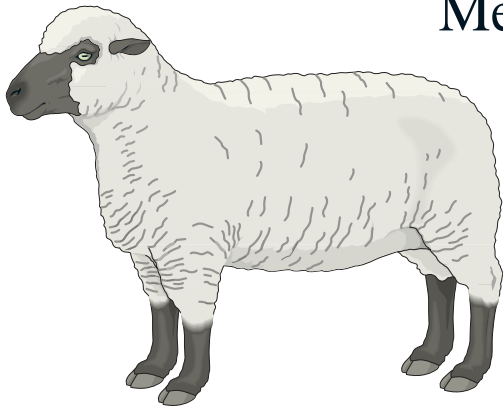

Meaitseáil iad seo.

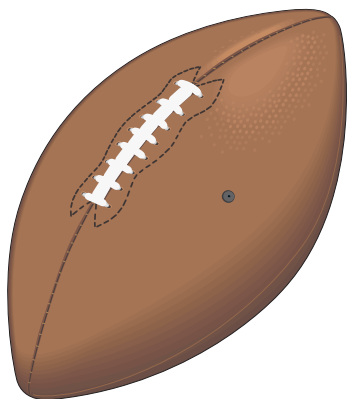
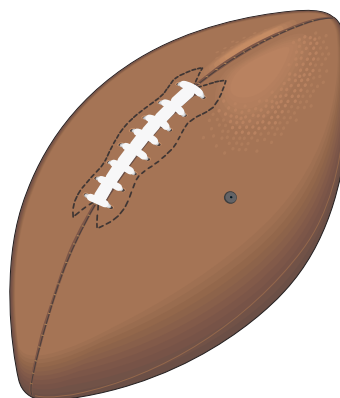
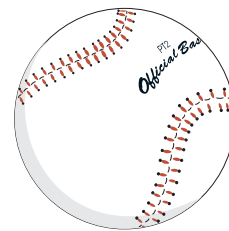

Meaitseáil iad seo.

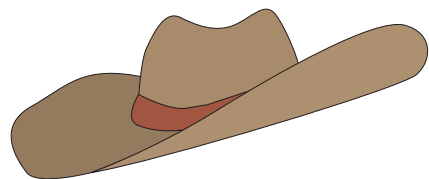
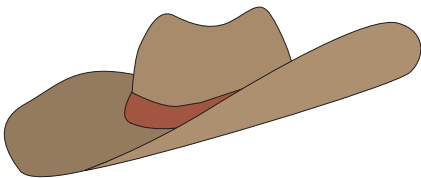

Meaitseáil iad seo.

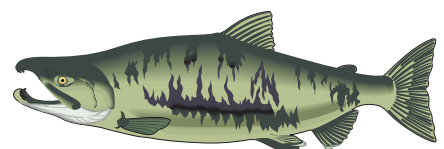
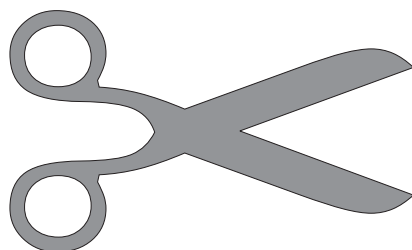
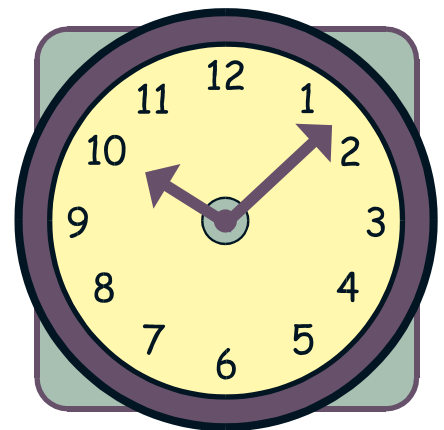
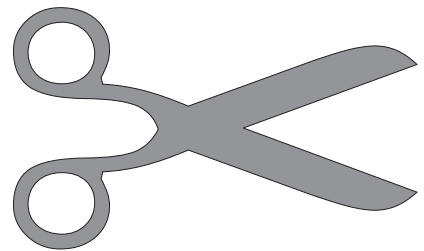
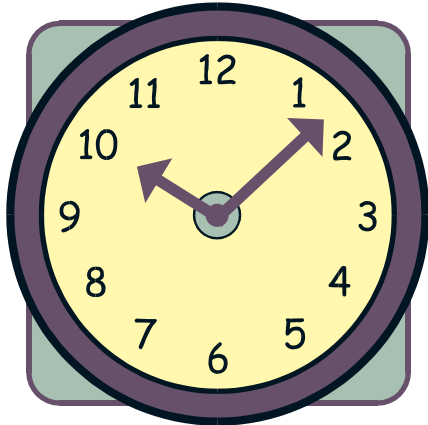
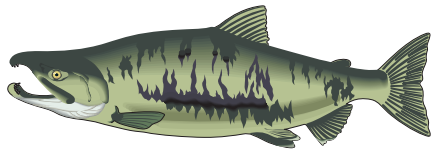

Meaitseáil iad seo.

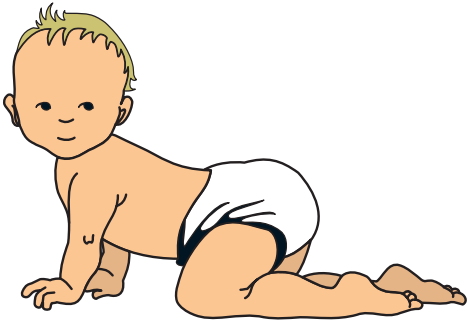
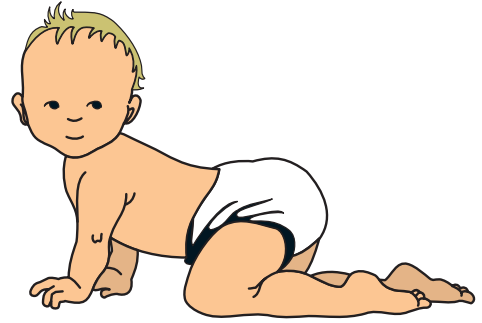
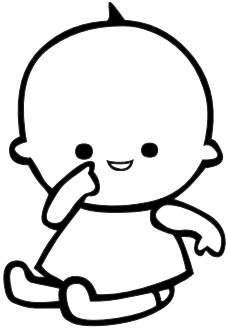

Meaitseáil iad seo.

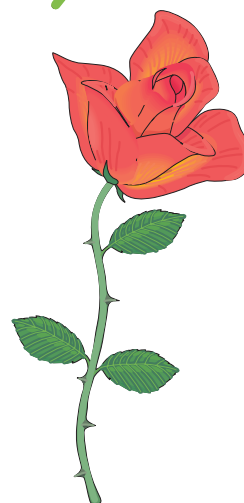
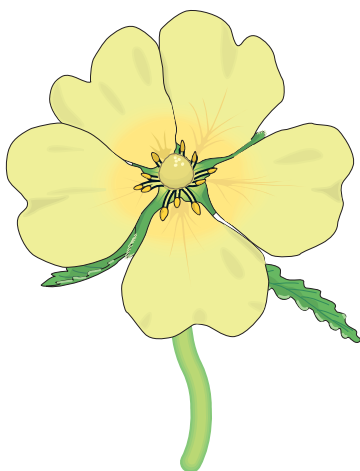
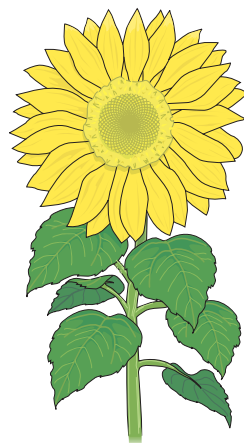
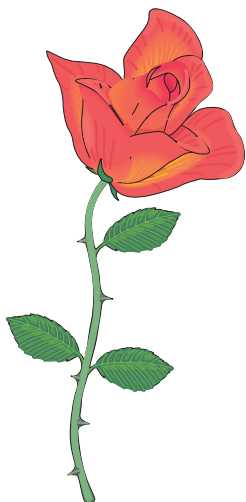
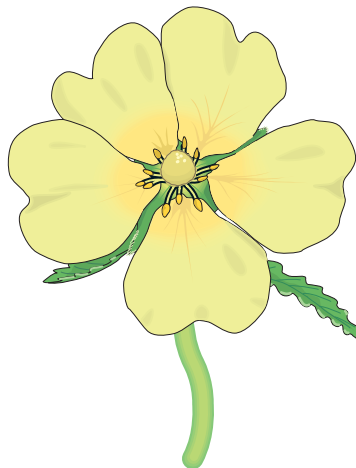
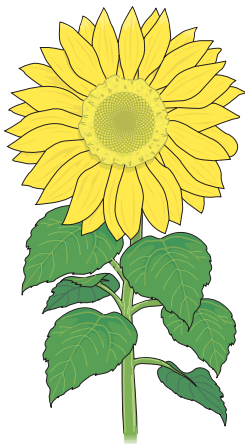

Tarraing líne timpeall ar gach tacar.

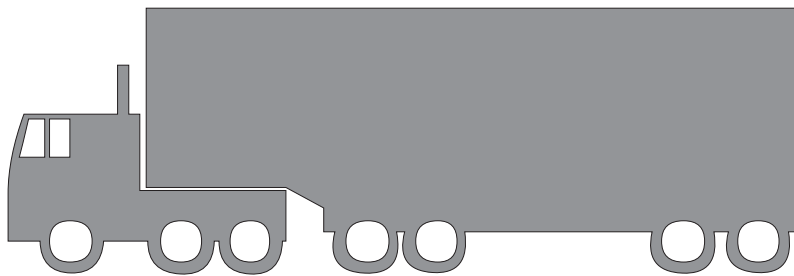
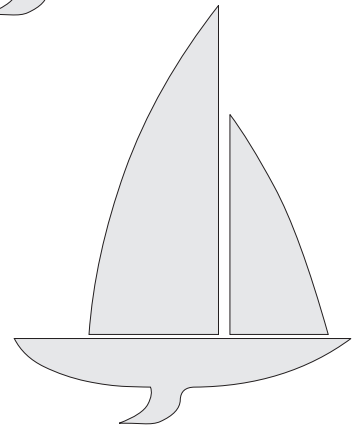
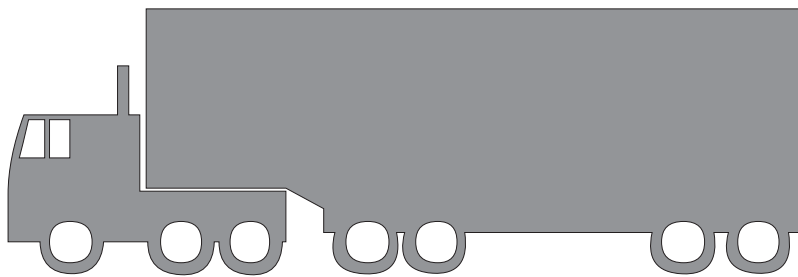
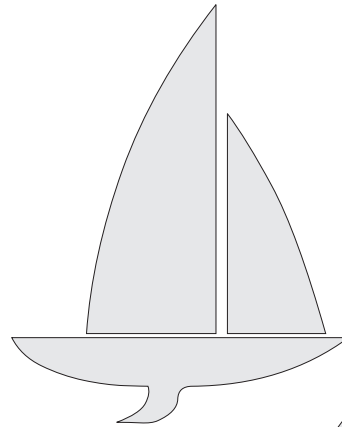
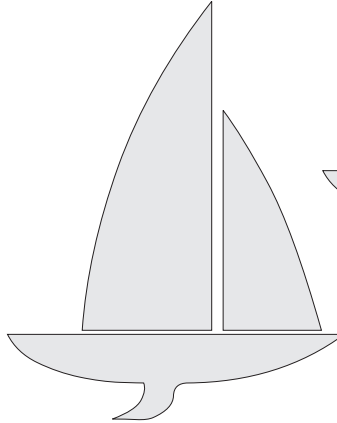
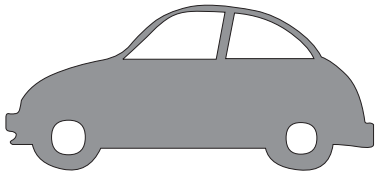
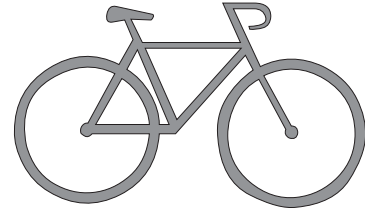
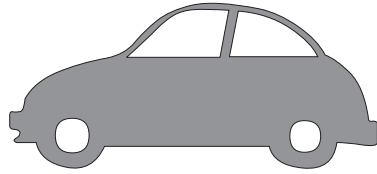
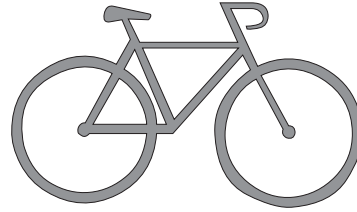
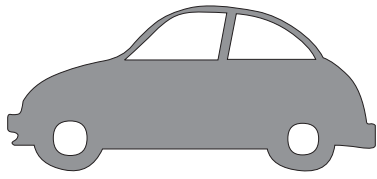

Tarraing líne timpeall ar gach tacar.

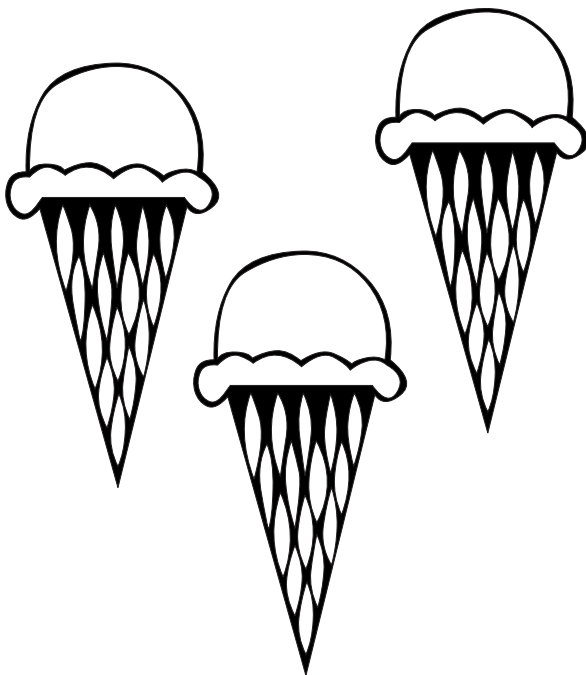
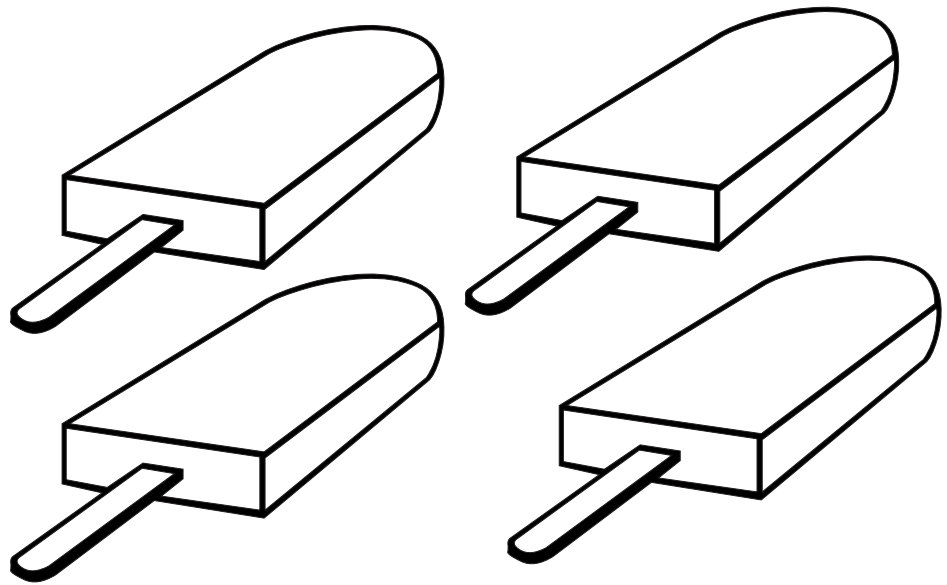
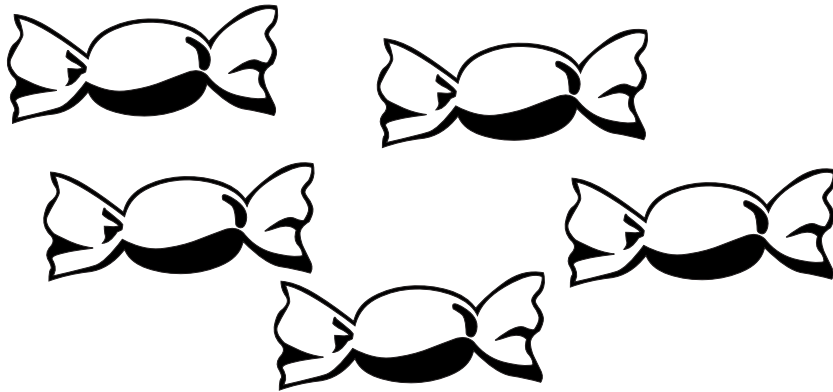

Tarraing líne timpeall ar gach tacar.

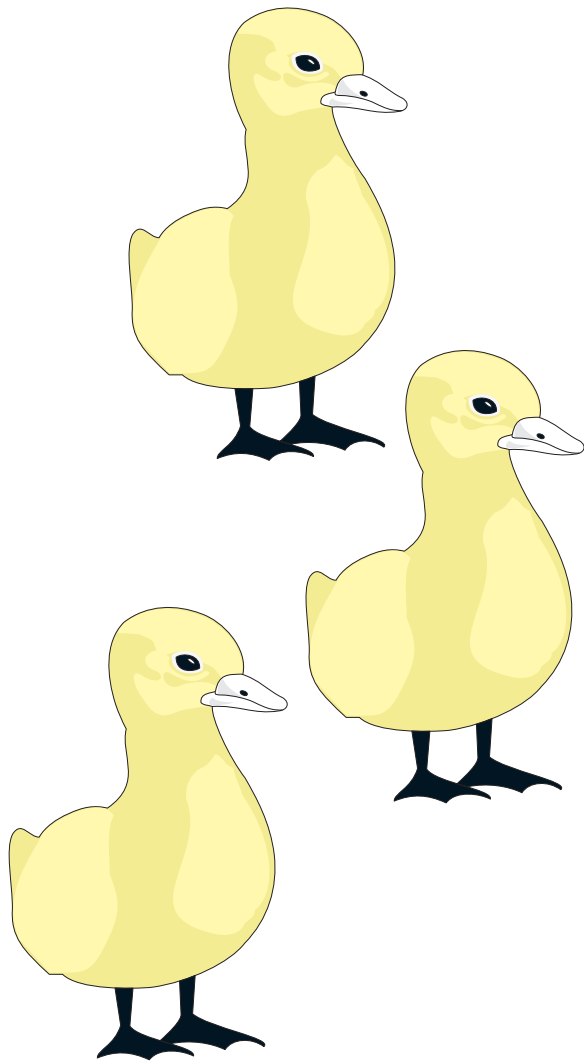

Tarraing líne timpeall ar gach tacar.

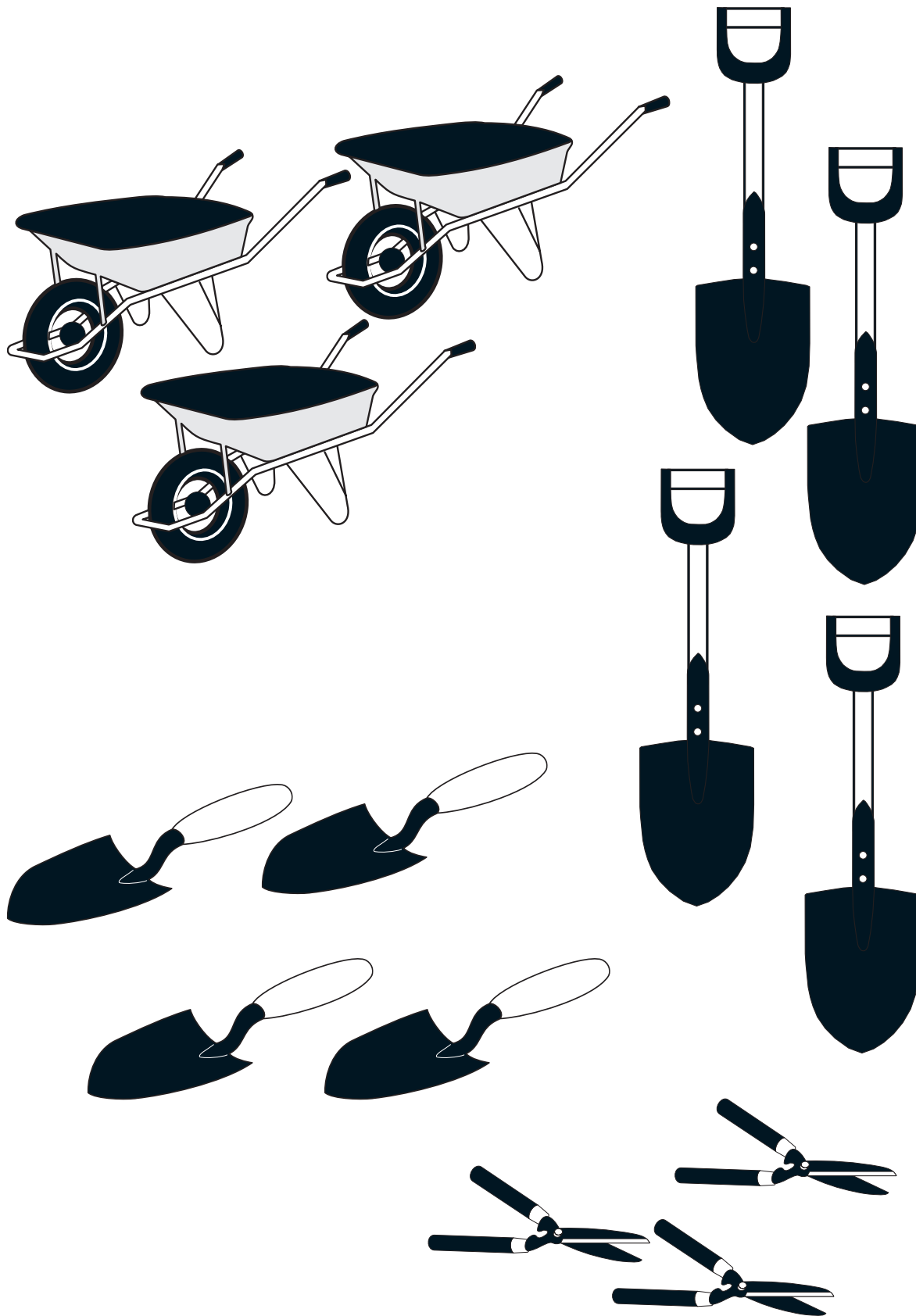

Tarraing líne timpeall ar gach tacar.



Cuir dath dubh ar na madraí.

Cuir dath buí ar na sicíní.

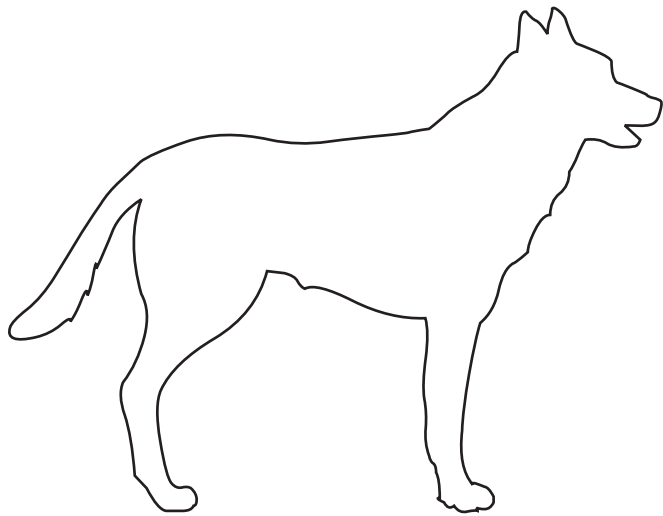
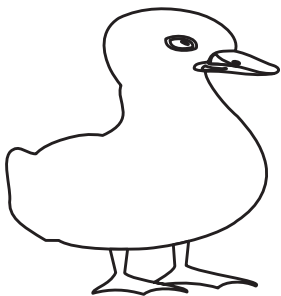
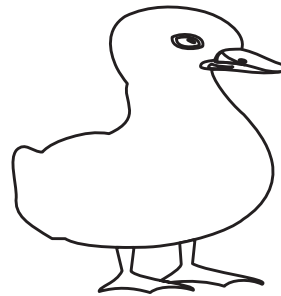
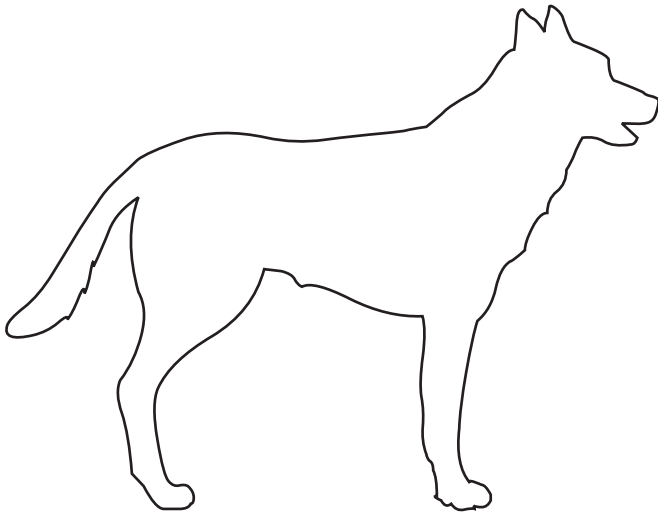
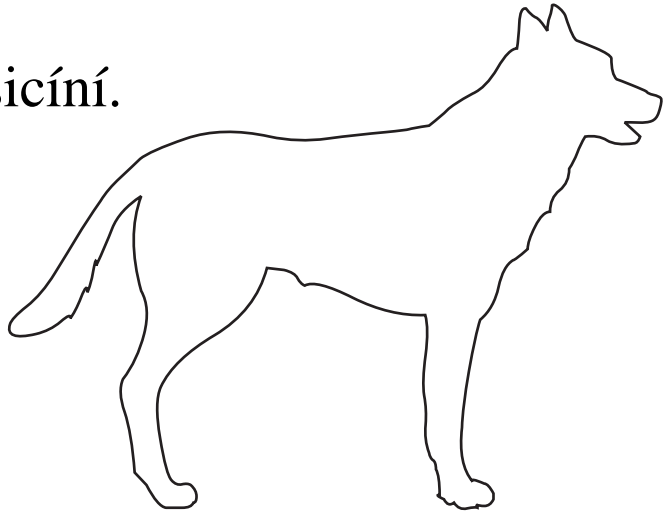
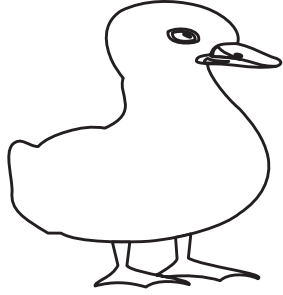

Meaitseáil iad seo.

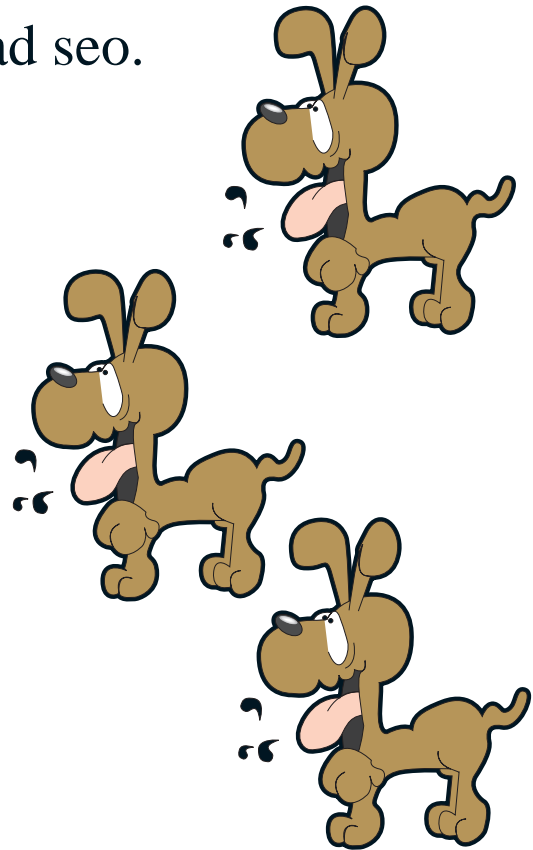
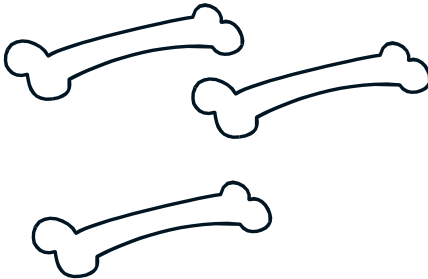

Tabhair buidéal do gach leanbh thíos.

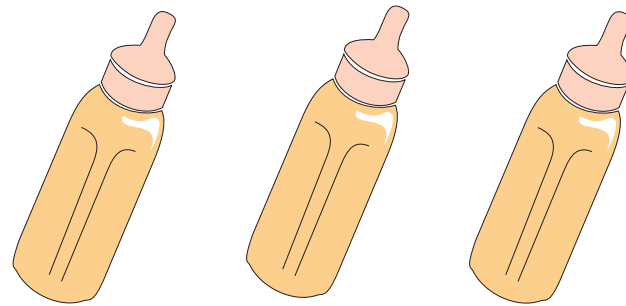

Tabhair líreacán do gach páiste thíos.



Tabhair clár scátála do gach cailín anseo.

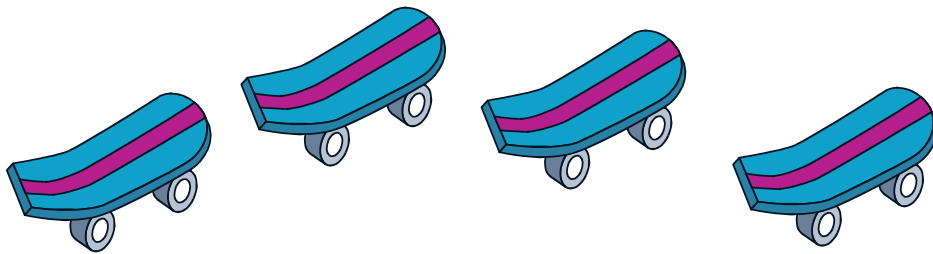

Tabhair pram do gach bábóg anseo.

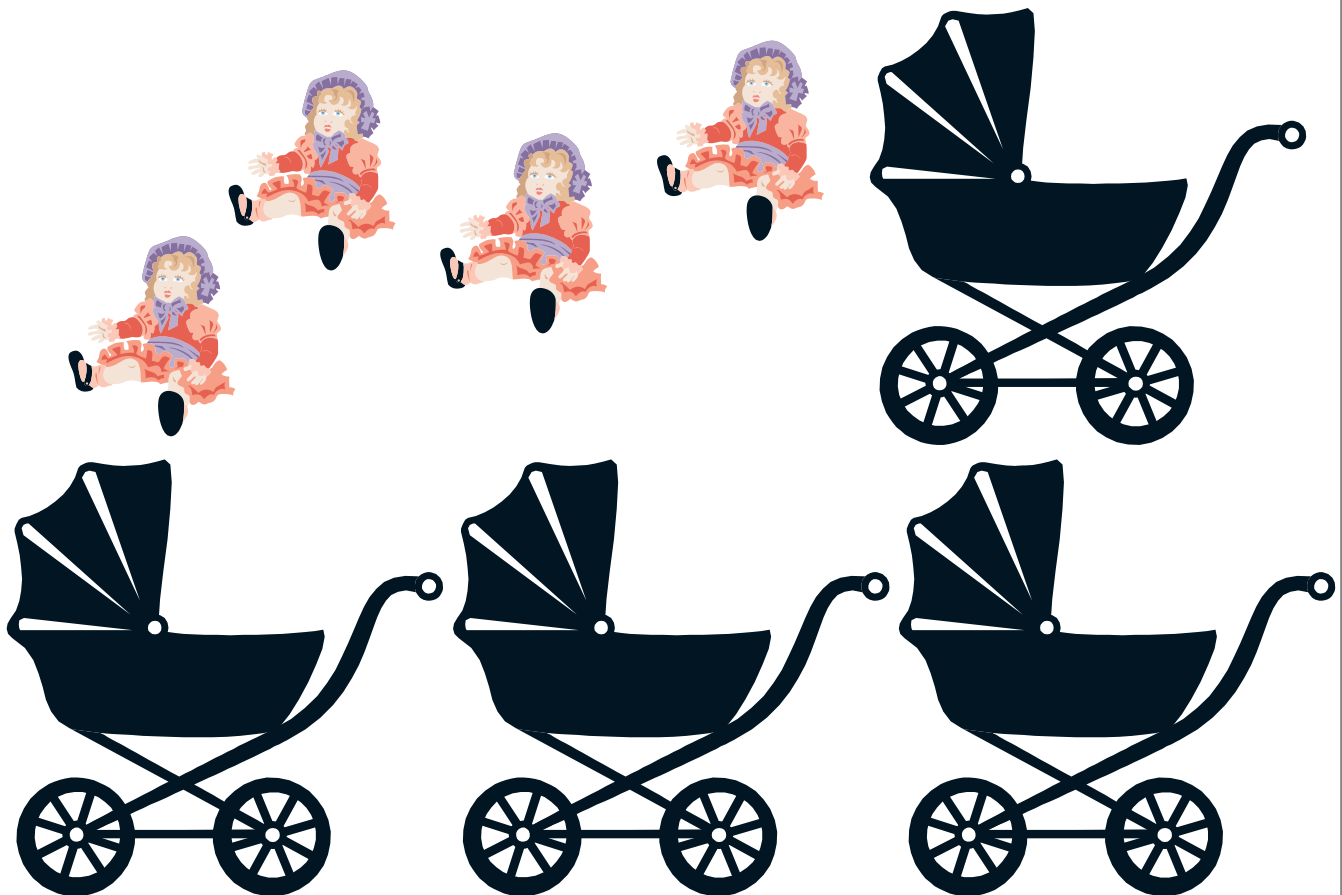

Tabhair spéaclaí do gach bean anseo.



Tabhair nead do gach éan thíos.



Tabhair scuab do gach cailleach anseo.



Ceangail gach réinfhia de charr sleamhnáin.

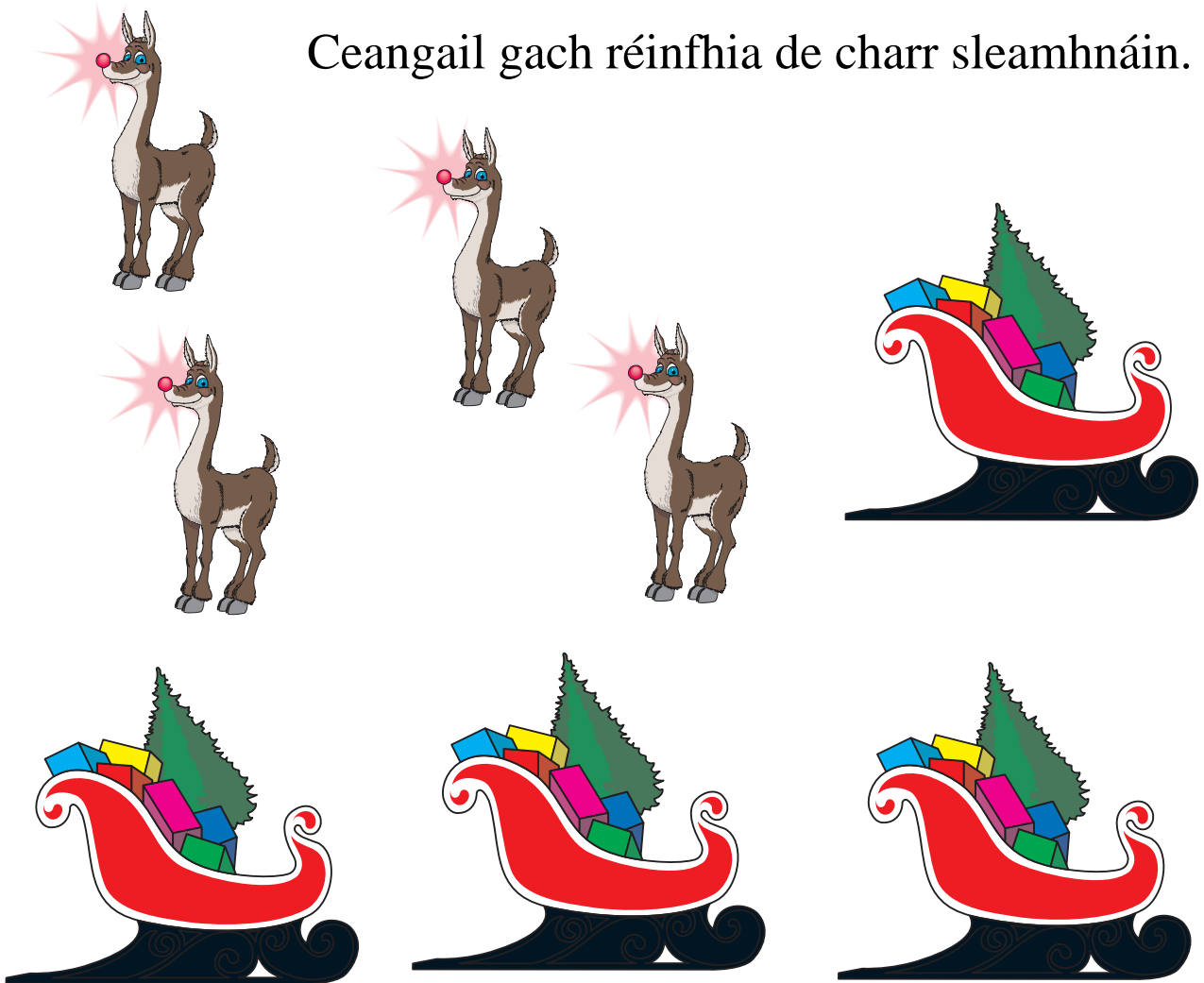

Tabhair a phota féin do gach bláth.

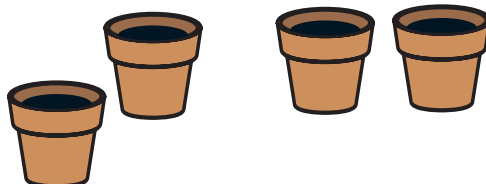
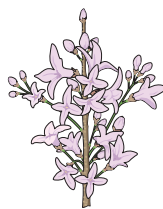
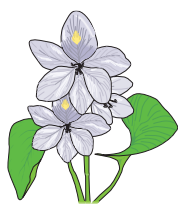

Luchóg an ceann do gach cat thíos.

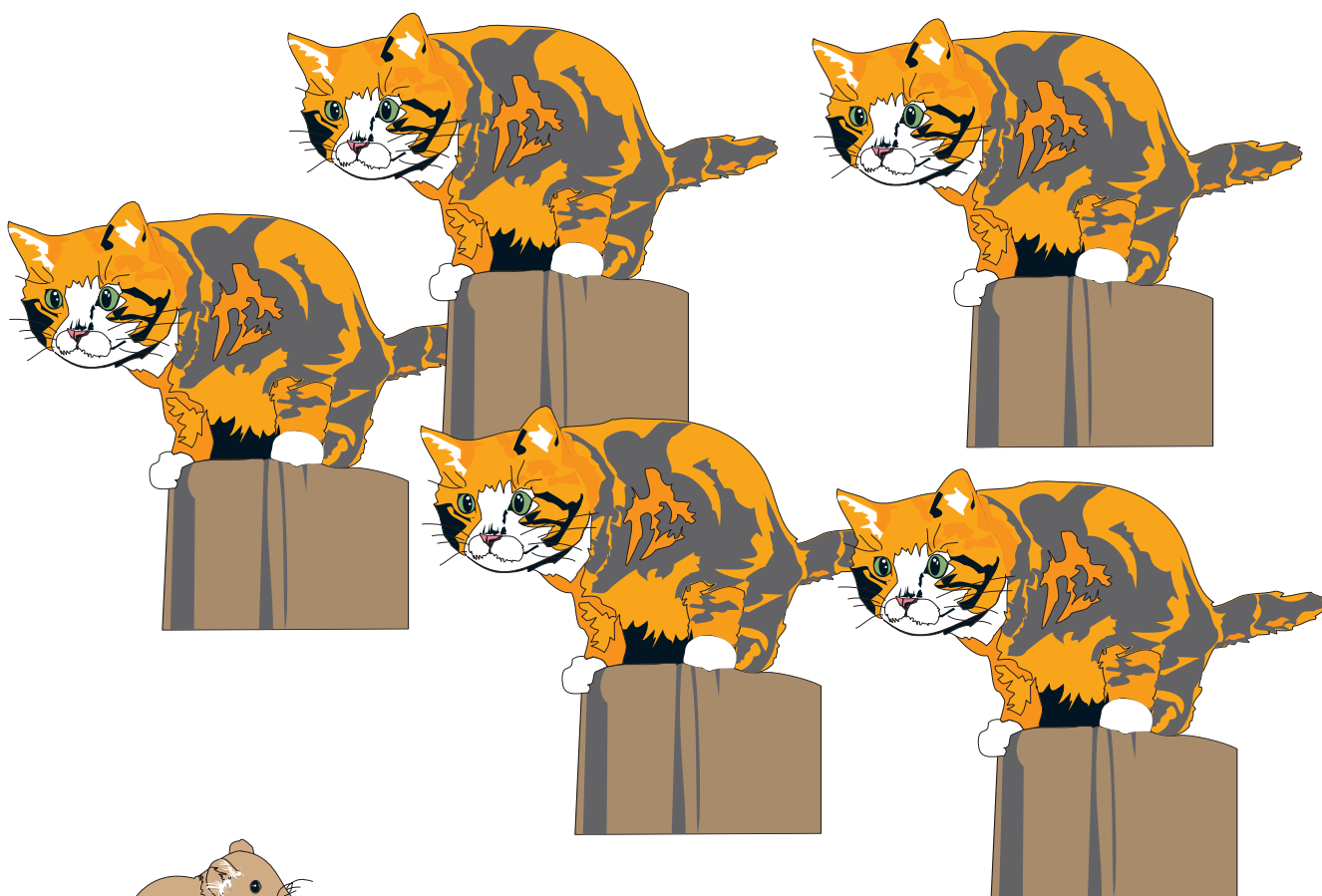

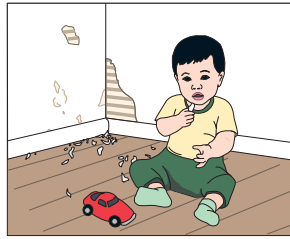

Tabhair carr an duine do gach buachaill anseo.

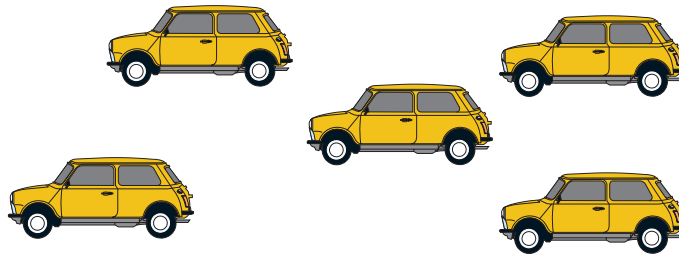

Meitseáil na cupáin leis na sásair.

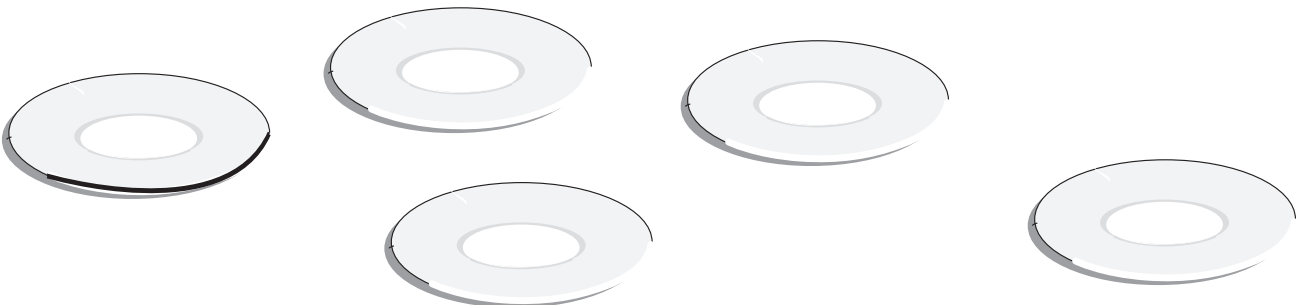
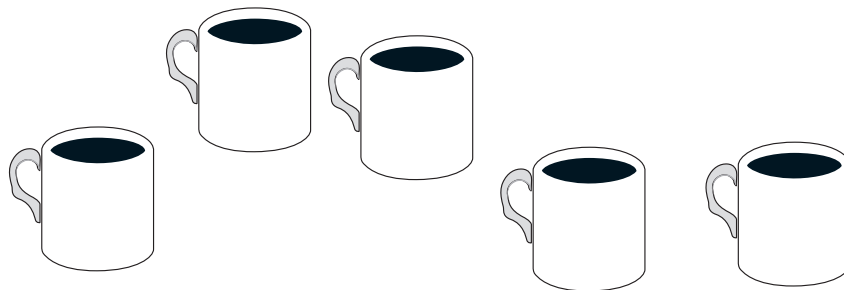

Tarraing borróg an duine do gach páiste anseo.

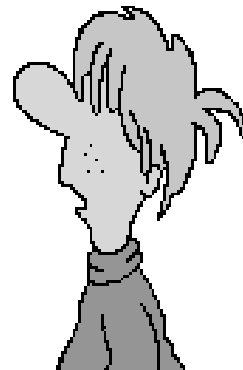



Tabhair cnámh amháin do gach madra anseo.



Tarraing balún amháin do gach cailín anseo.

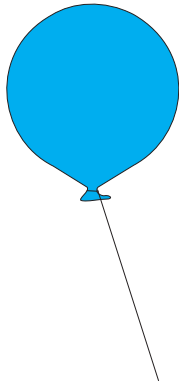

Tarraing réalta amháin do gach sióg thíos.

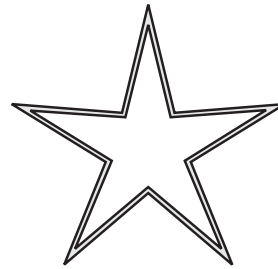

Tarraing oráiste an duine do gach buachaill thíos.

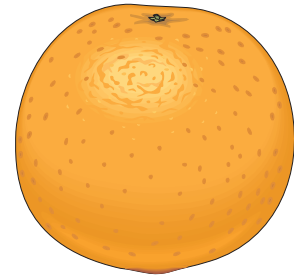

Tarraing scuab fiacla do gach páiste anseo.

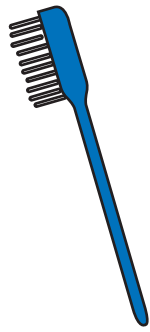





I

a hAon
Ceann amháin

a hAon

|

⋮

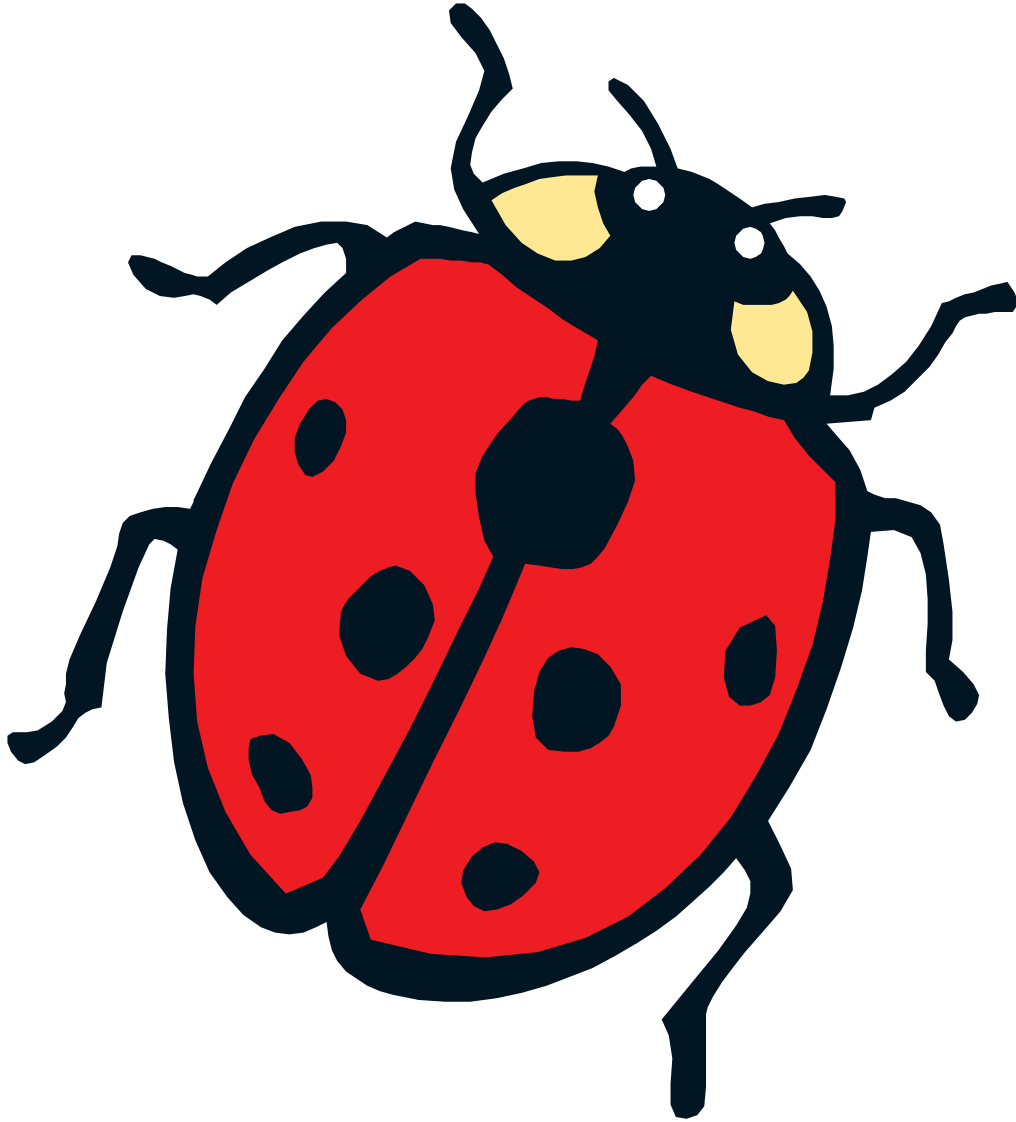

Ceann amháin

⋮ ⋮ ⋮ ⋮ ⋮ ⋮

a hAon



Ceann amháin



a hAon

|

⋮

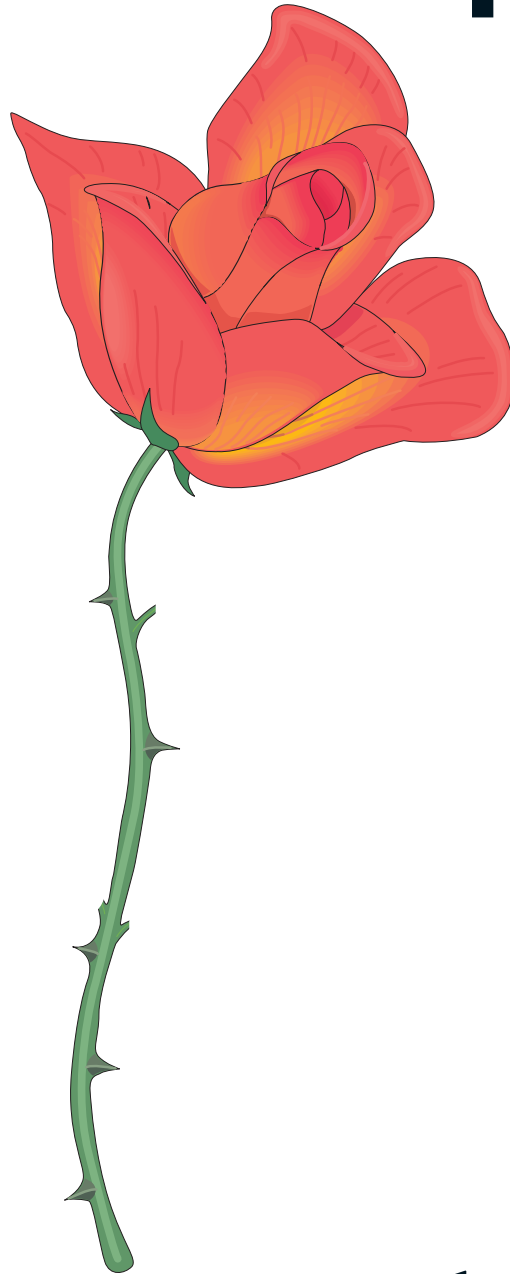

Ceann amháin

⋮ ⋮ ⋮ ⋮ ⋮ ⋮ ⋮

Súil amháin

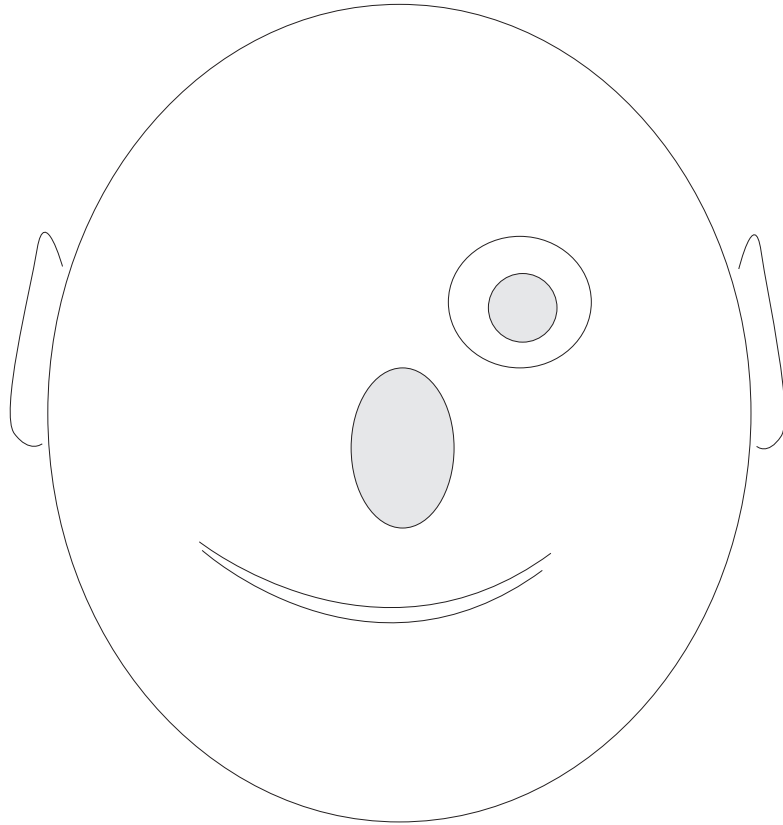

Ceann amháin

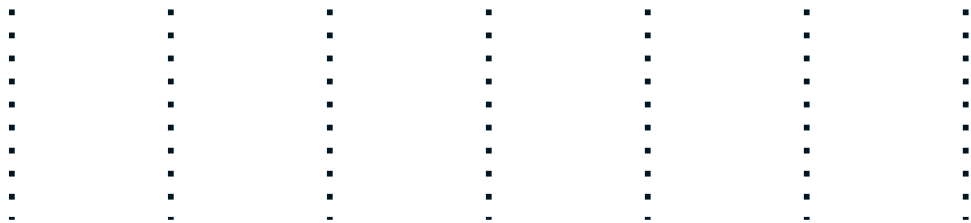

a Dó 2 



Dhá cheann

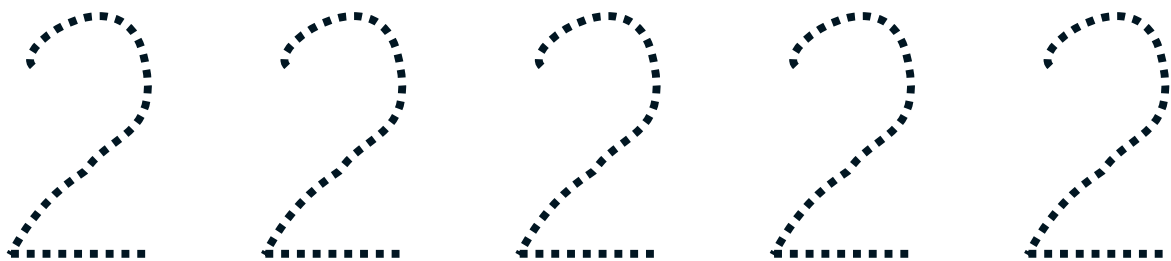

a Dó 2

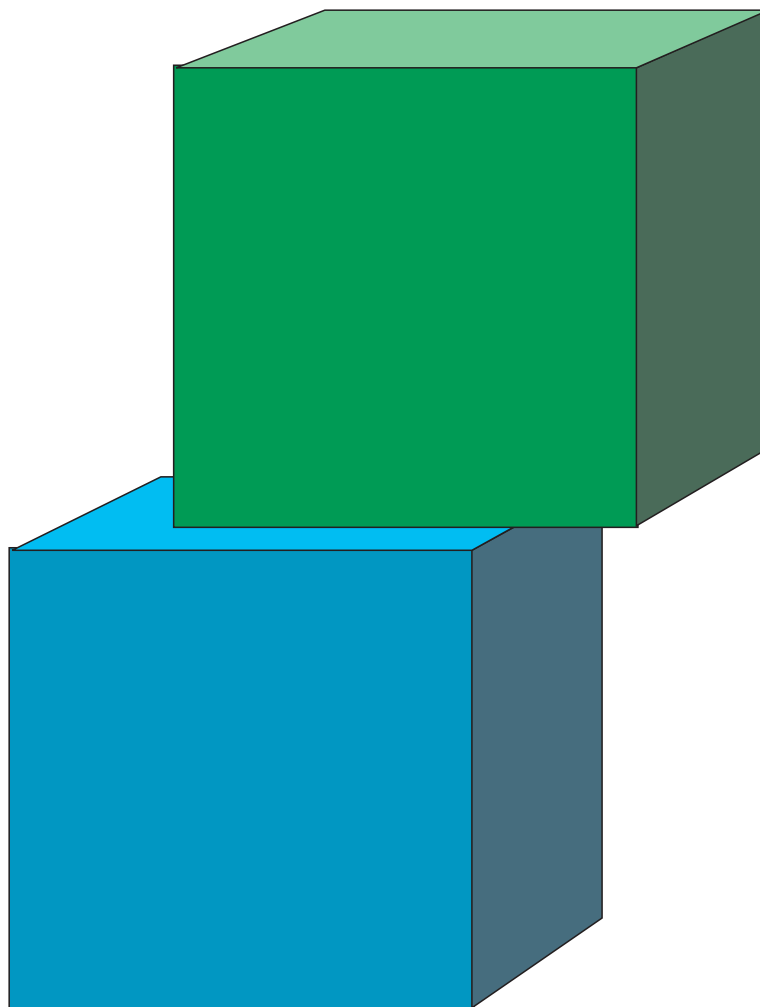
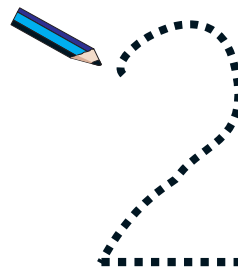

Dhá cheann



a Dó 2

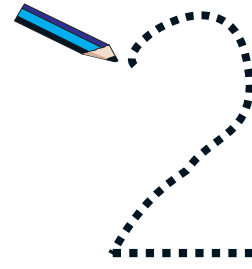

Dhá cheann

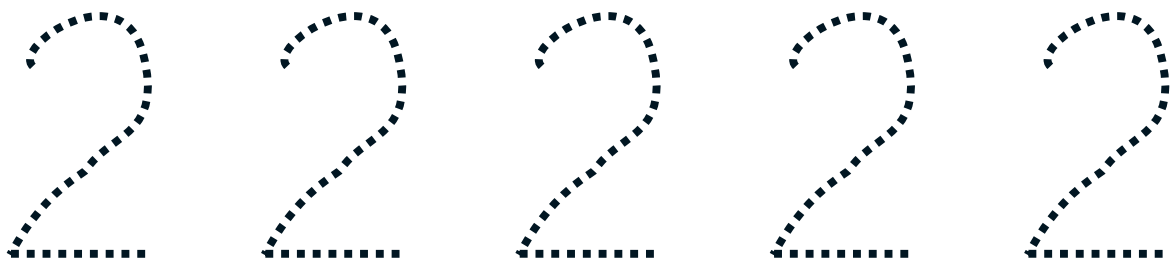

a Dó

2

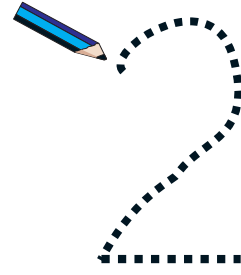

Dhá cheann



a Dó

2

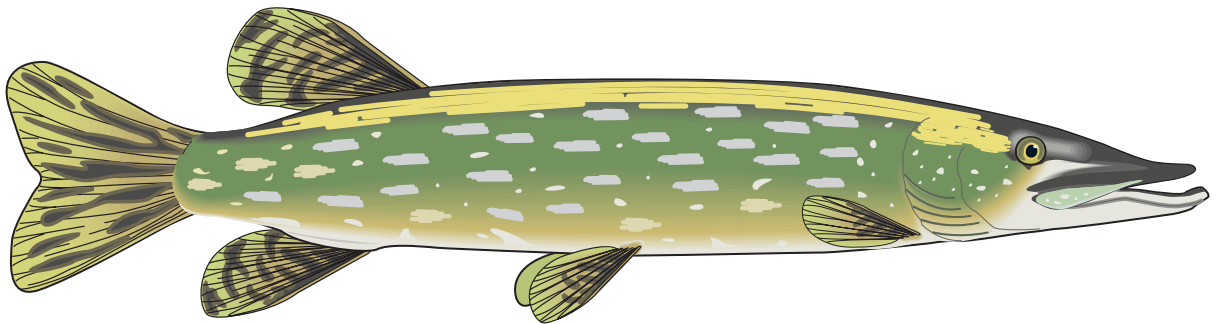
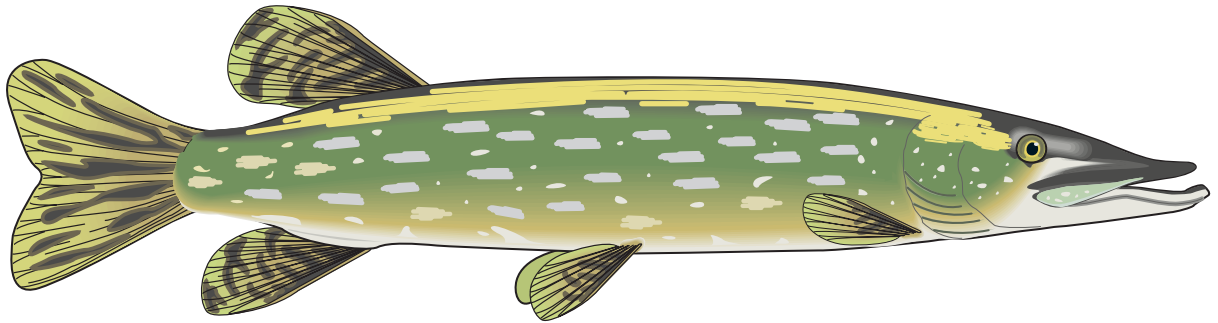
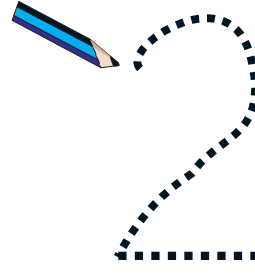

Dhá cheann



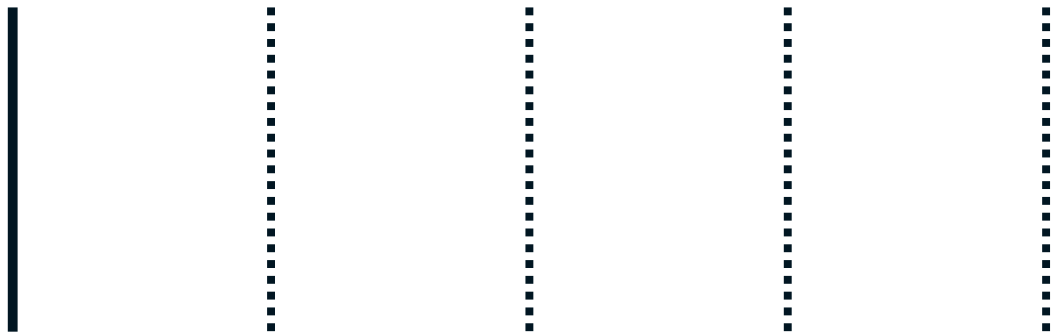
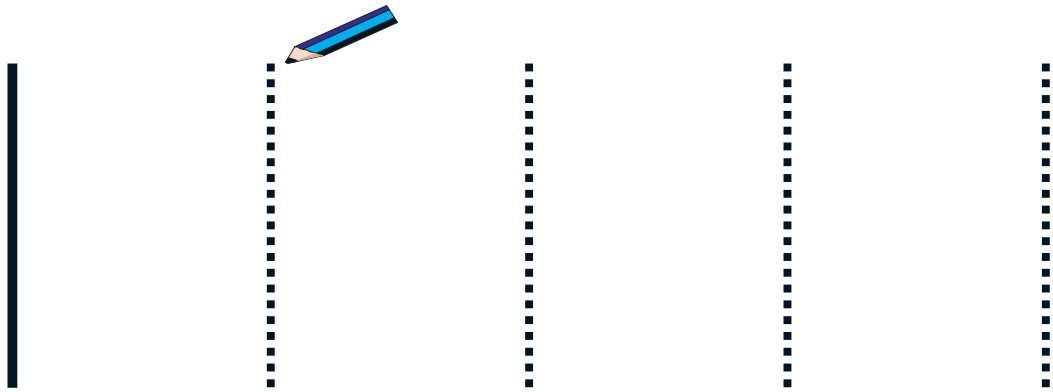

Cuir líne timpeall ar na tacair ina bhfuil dhá cheann (2).

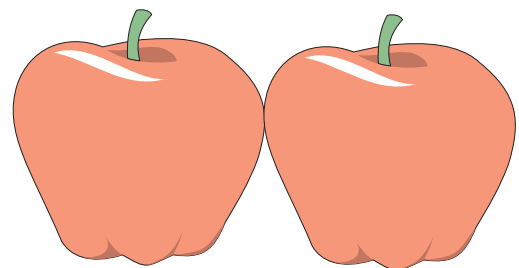
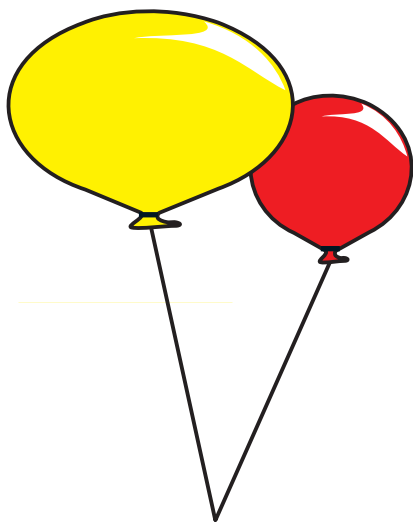
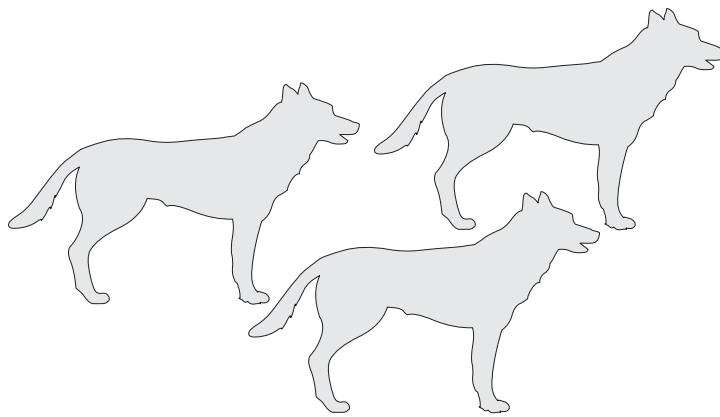
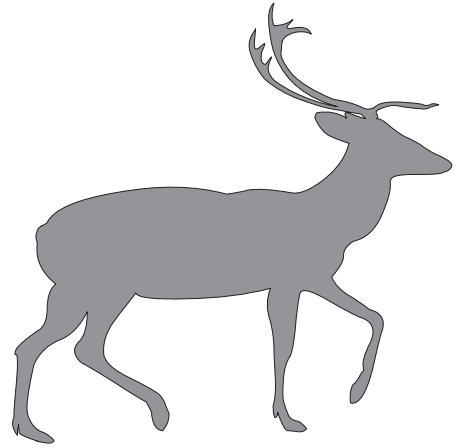
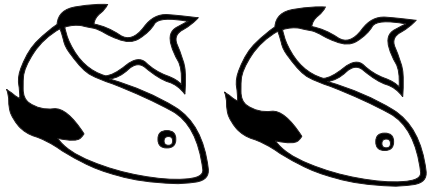

Cé mhéad rud
i ngach tacar?

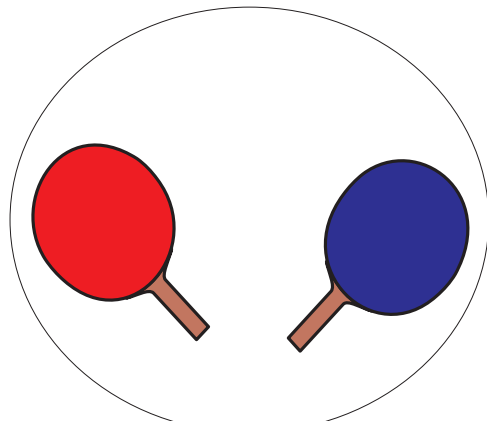
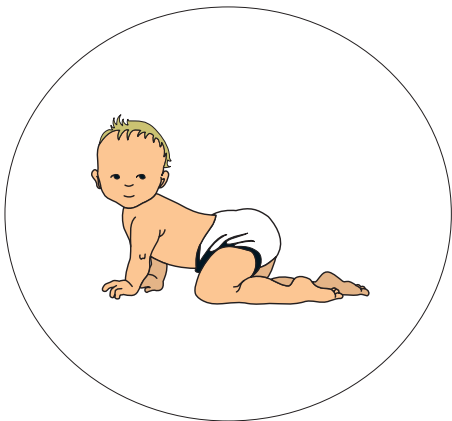
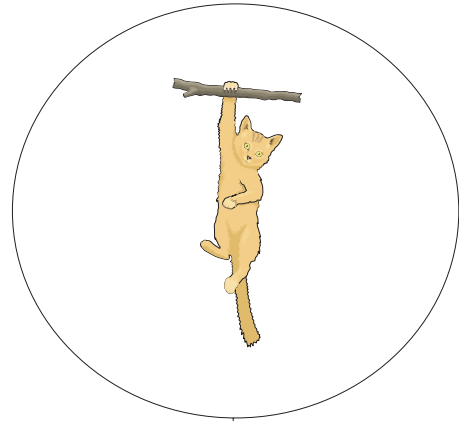
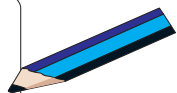
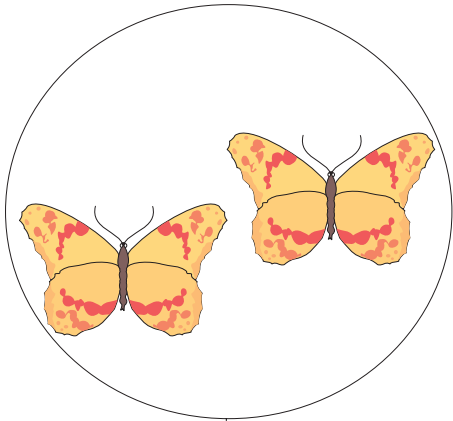
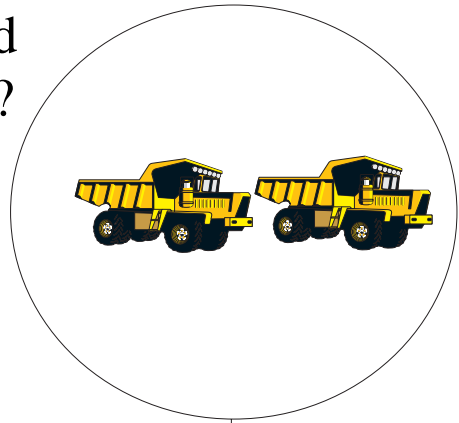
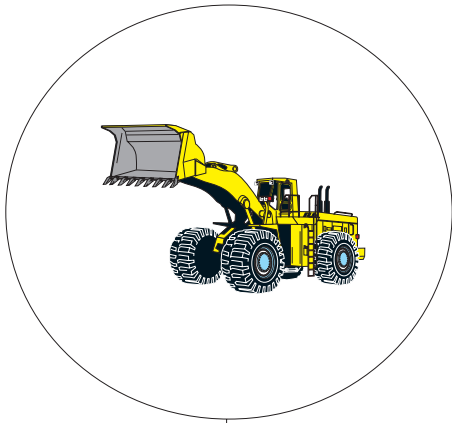

Cé mhéad rud
i ngach tacar?

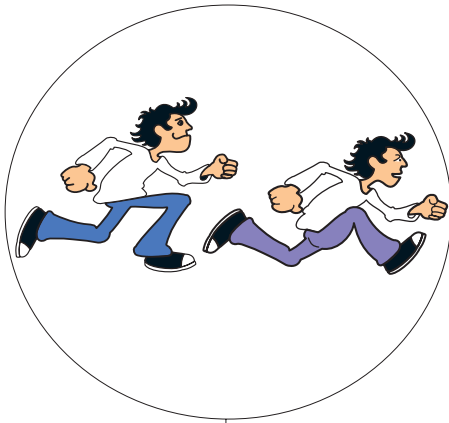

□ 



□ 



□ 

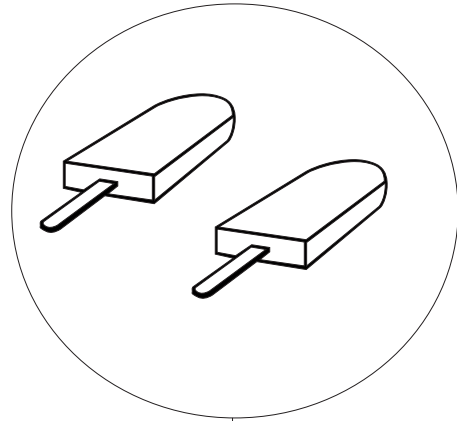

□ 

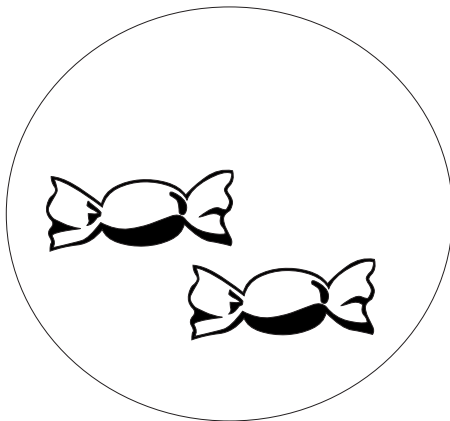

□ 

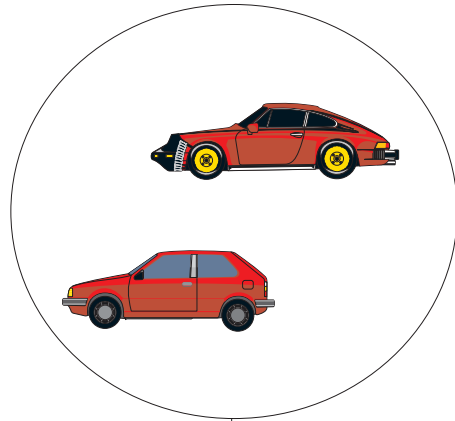

□ 

□

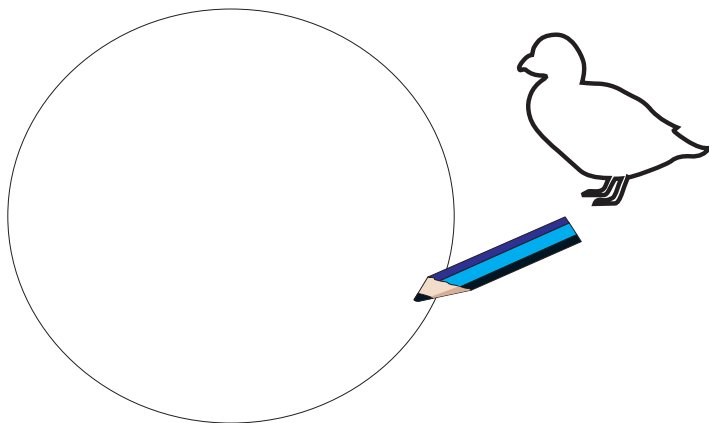

1

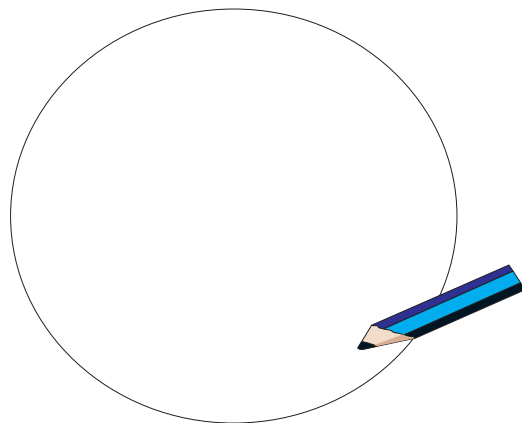

2

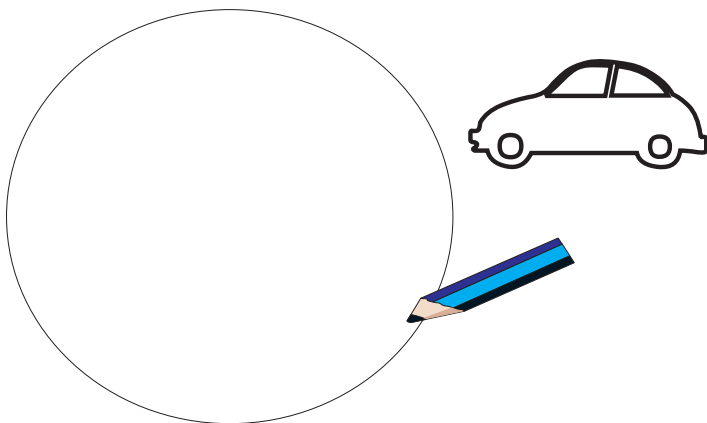

2

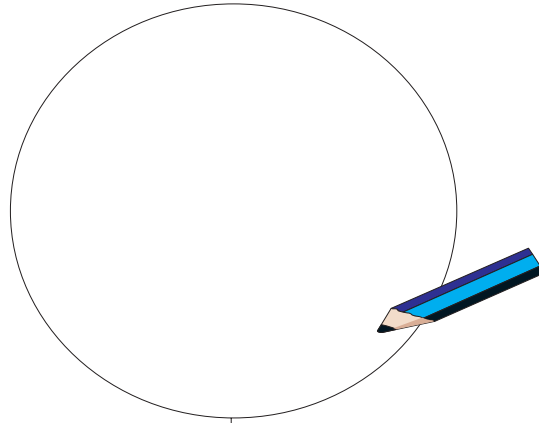

1

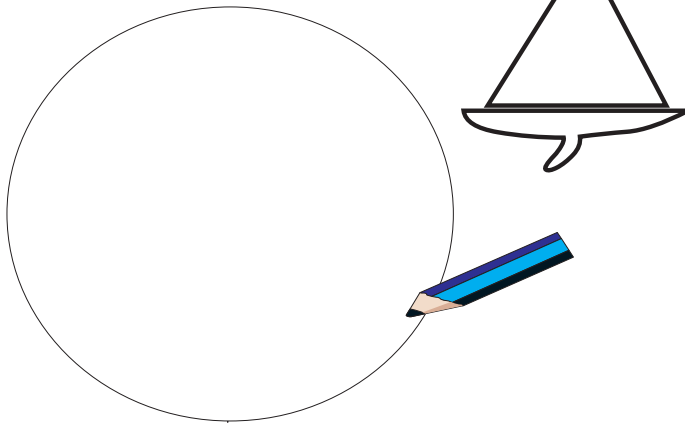

2

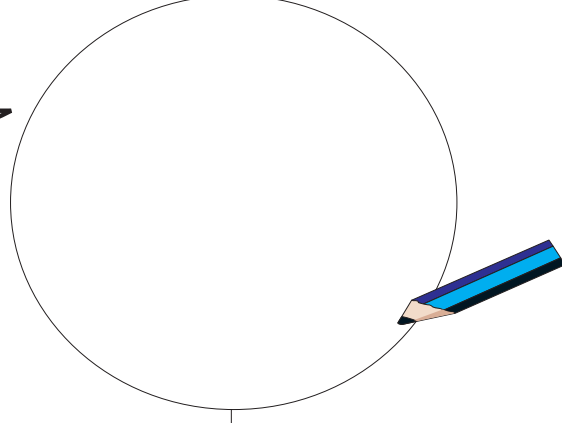

2

a Trí

3

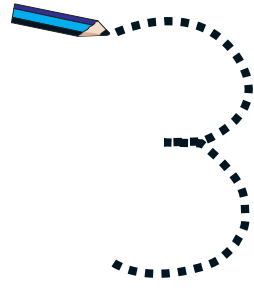

Trí cinn

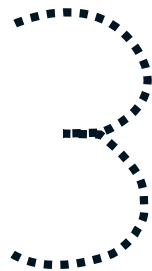

a Trí 3 3

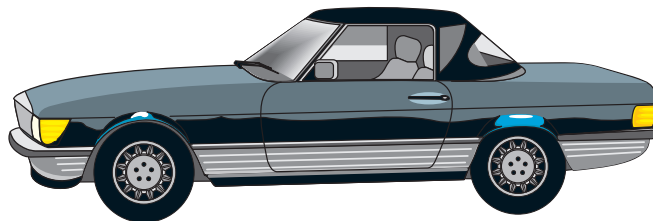
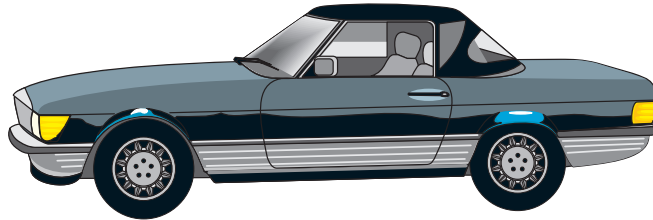
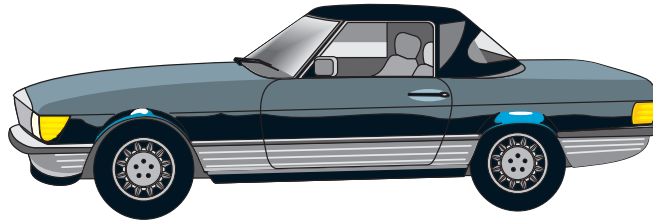

Trí cinn



a Trí

3

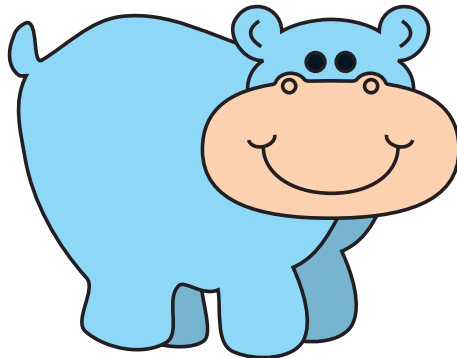
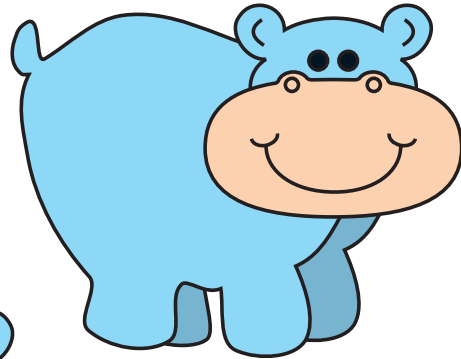
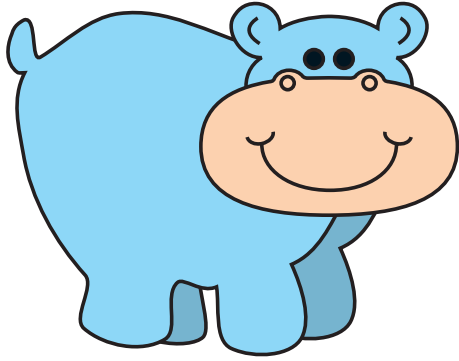

Trí cinn

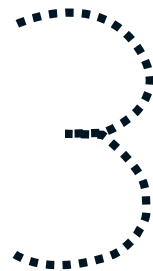

Ceangail gach carr thíos den teach ceart.

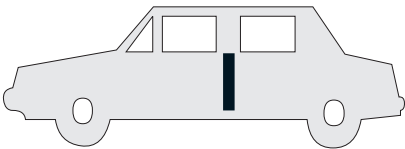
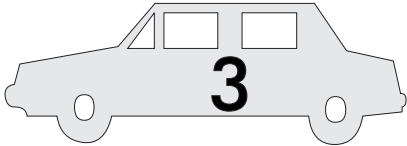
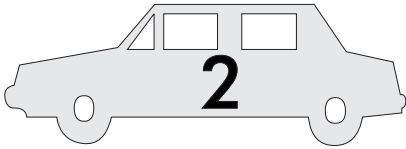

Meaitseáil iad seo.

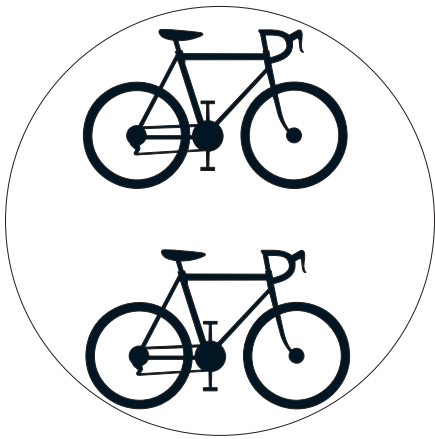

Cé mhéad rud
i ngach tacar?

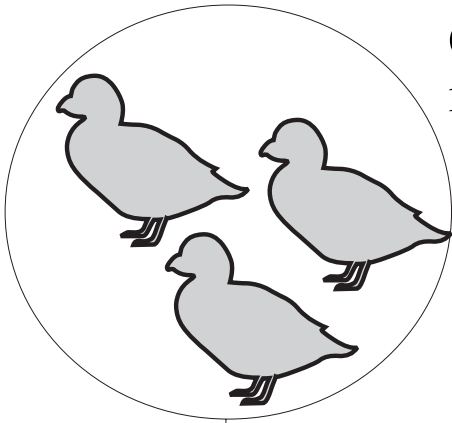

Blank box with a pencil icon pointing to it.

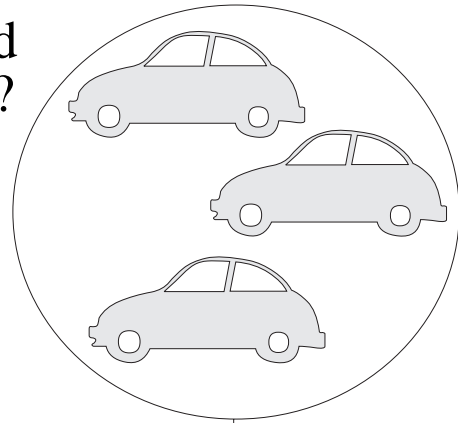

Blank box with a pencil icon pointing to it.

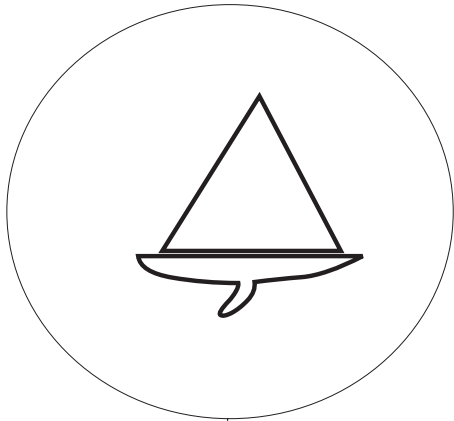

Blank box with a pencil icon pointing to it.

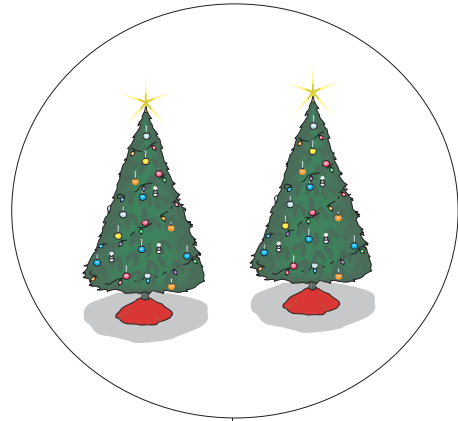

Blank box with a pencil icon pointing to it.

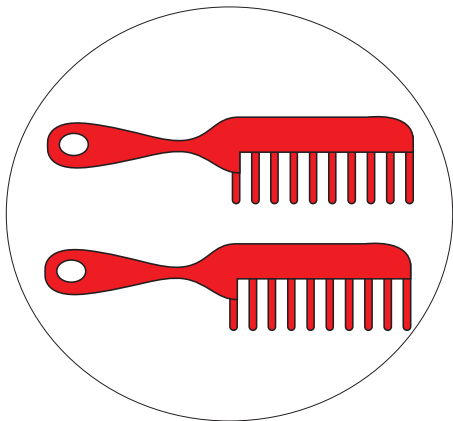

Blank box with a pencil icon pointing to it.



Blank box with a pencil icon pointing to it.

Blank box for the score.

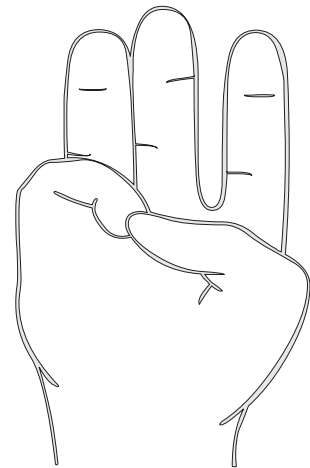
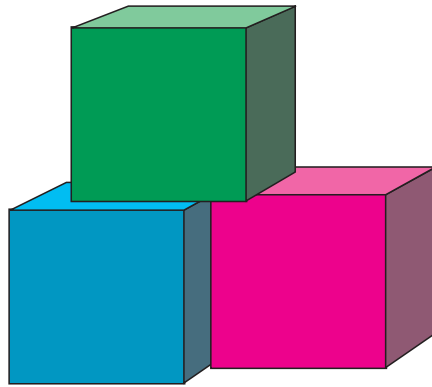

3

3

3

3

3

3

3

3

3

3

3

3



3

3

3

3

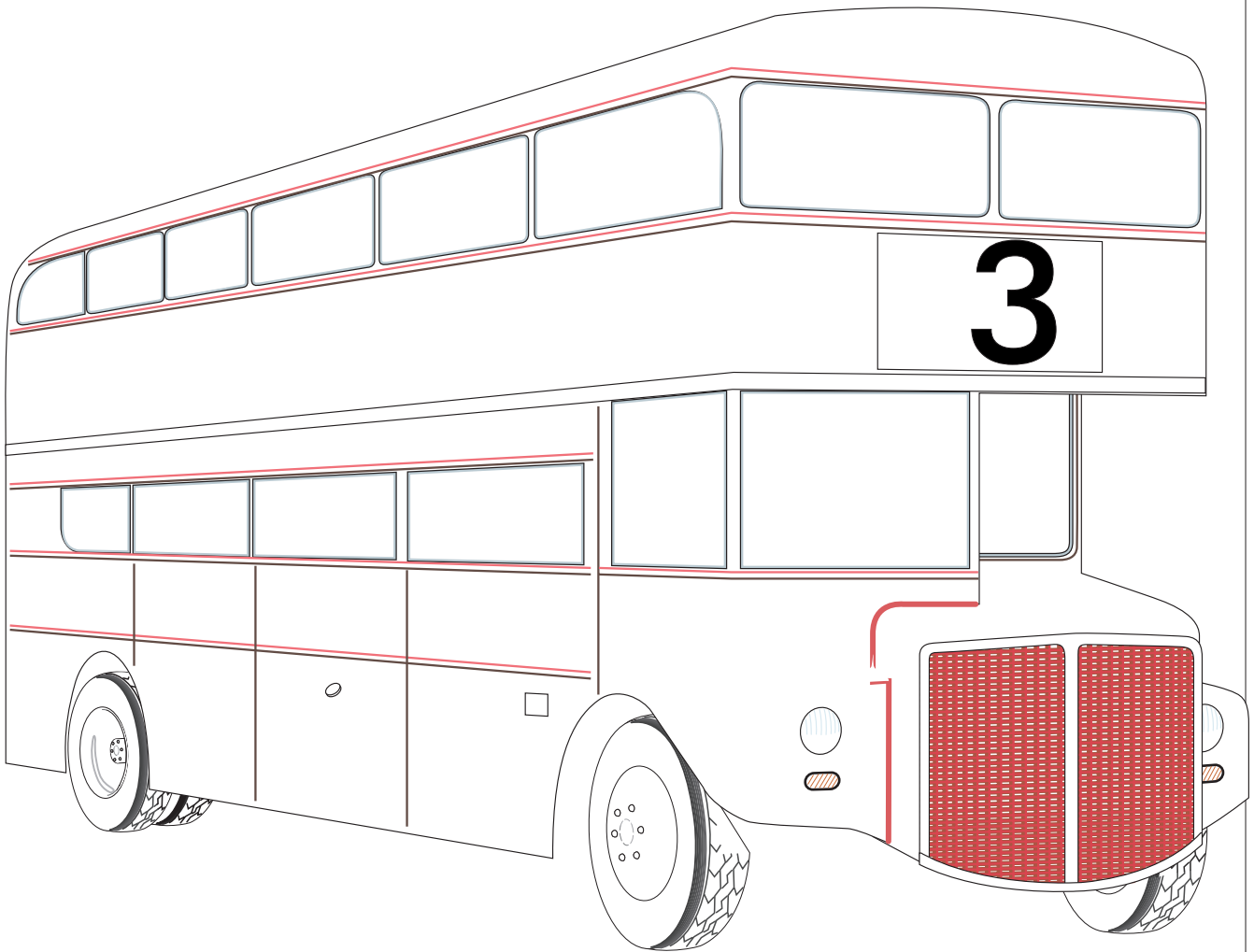

3

3

3

3

3

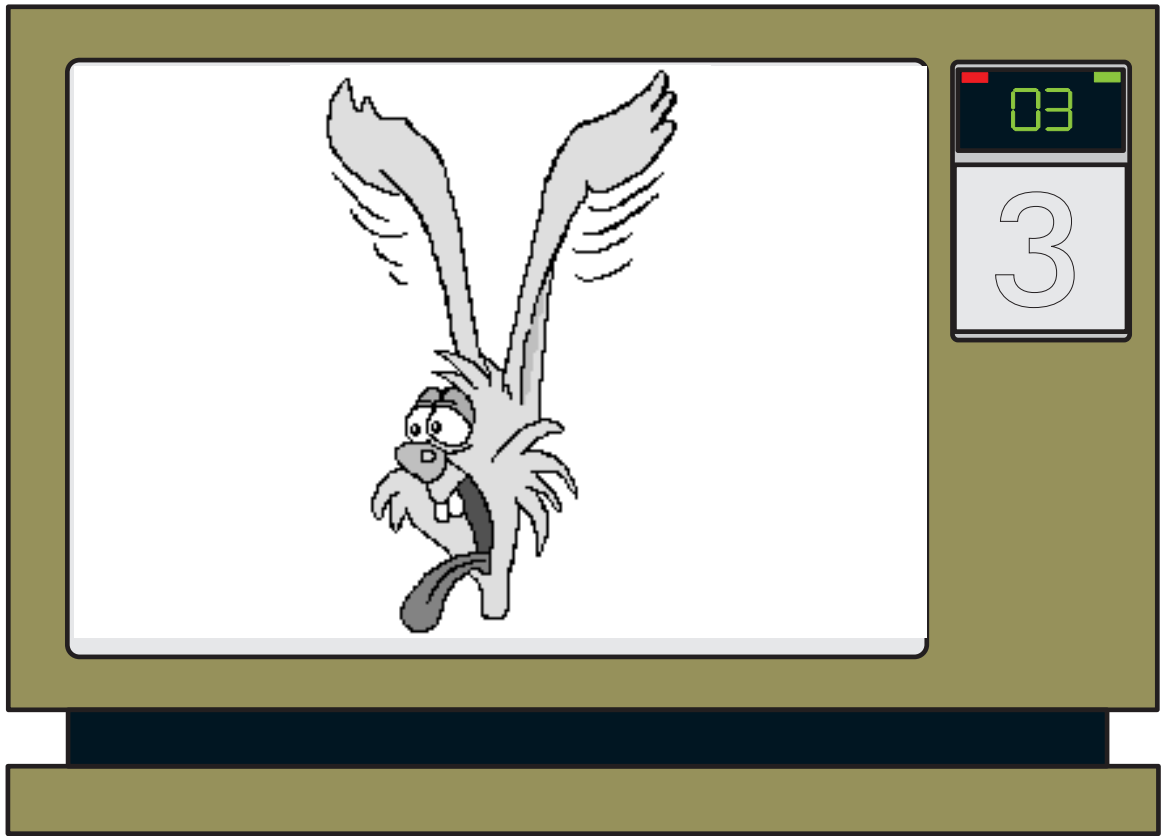

3

3

3

3

3

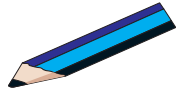
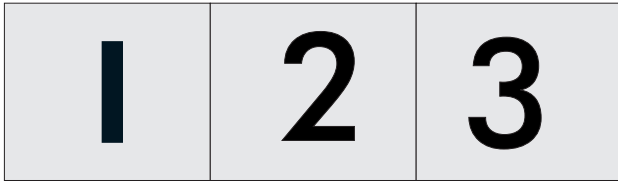
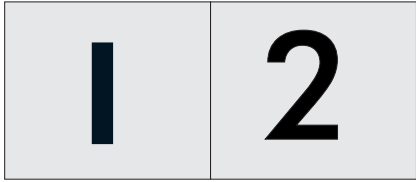
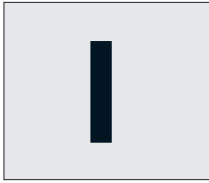

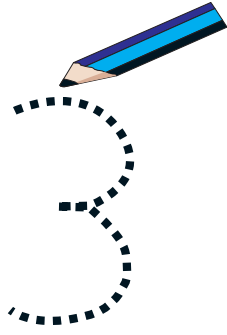

Meaitseáil iad seo.

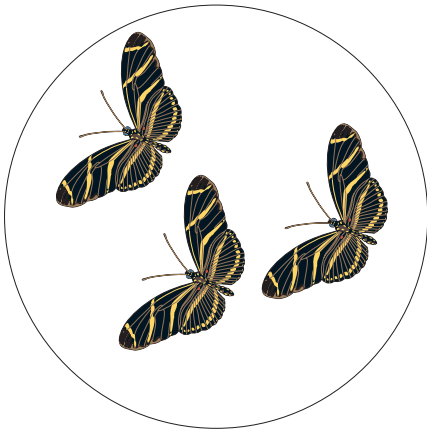
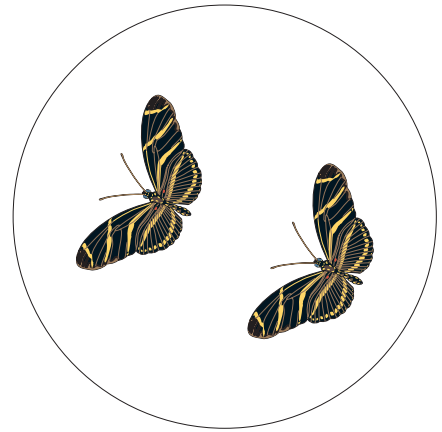

3

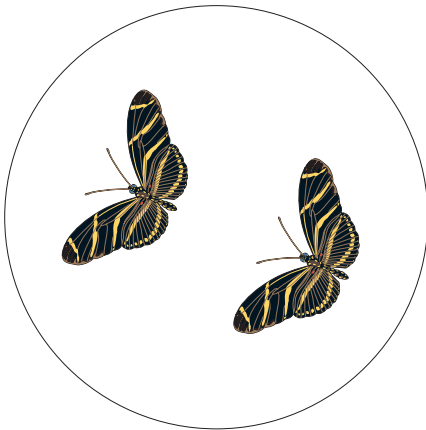
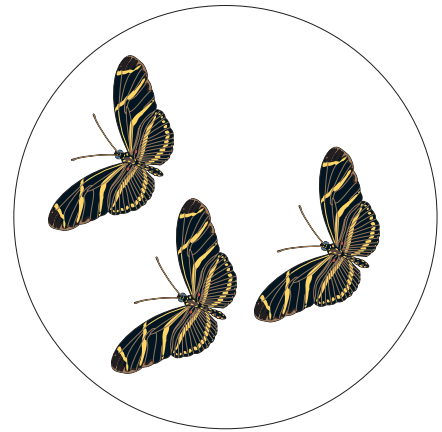

Meaitseáil iad seo.

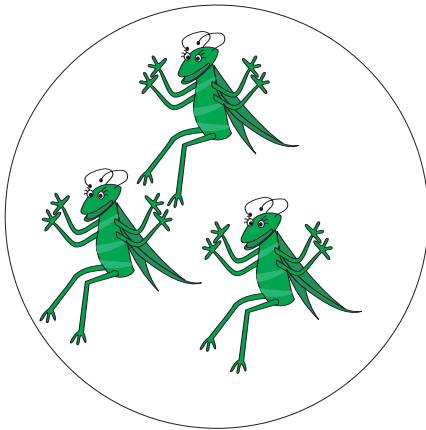
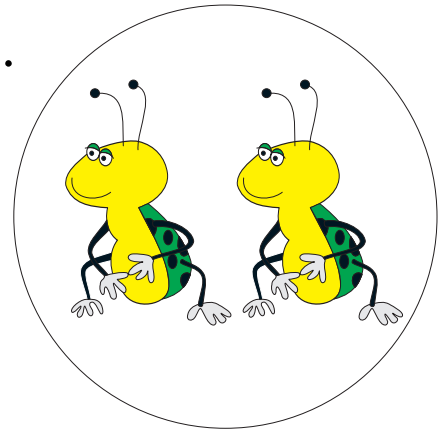
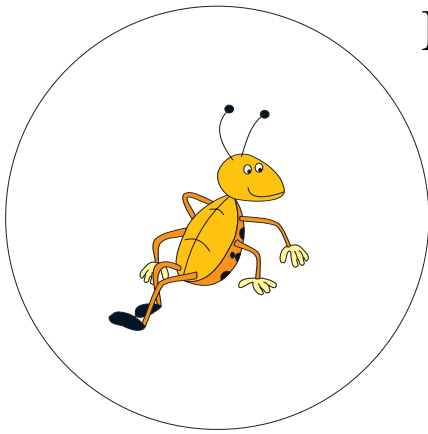

3

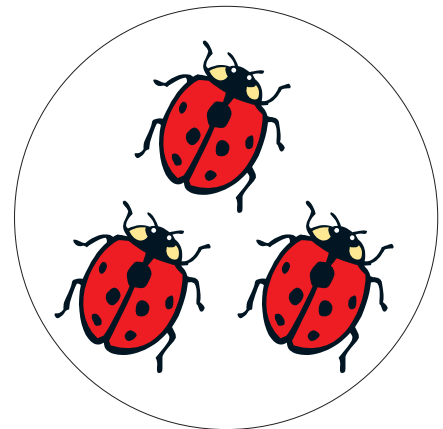
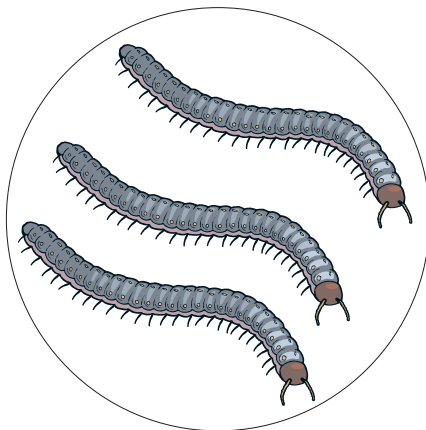
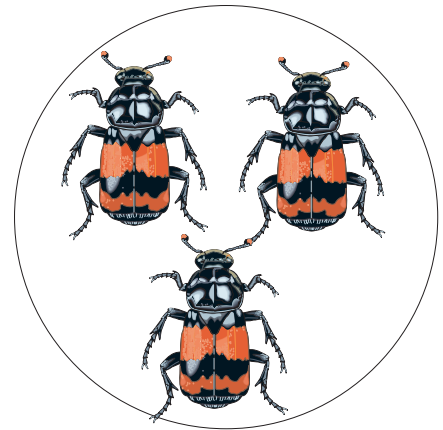

Meaitseáil iad seo.

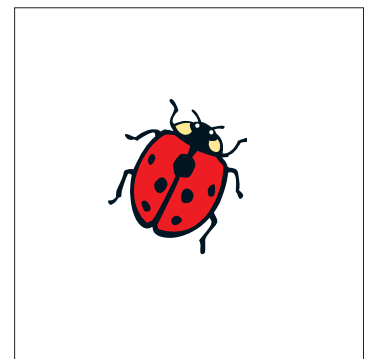
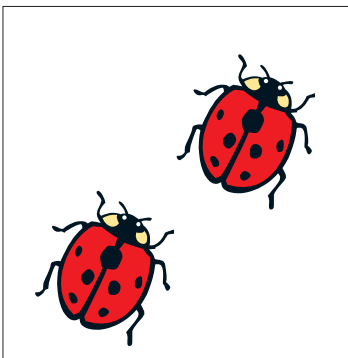
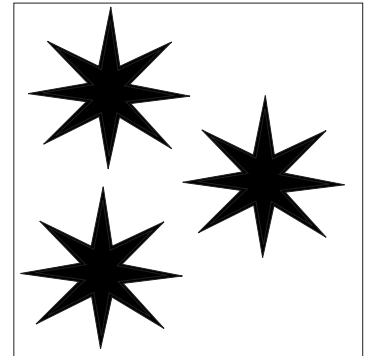
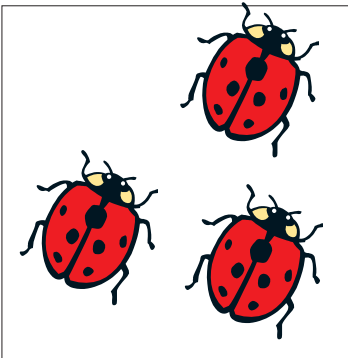
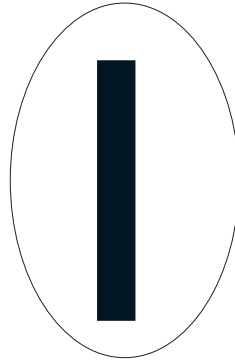
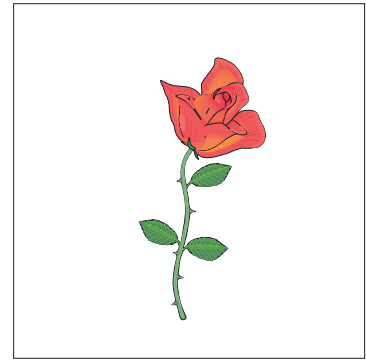
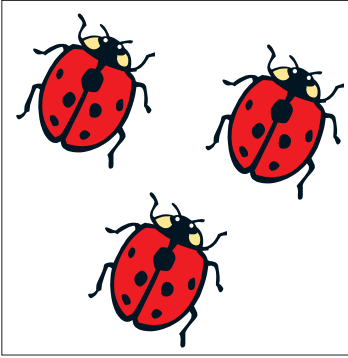

4

4

4

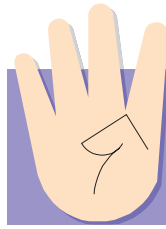

a Ceathair

4

4

4

4

4

4

4

4

4

4

4

4

4

4

4

Ceithre cinn

4

4

4

4

4

Cuir líne timpeall ar na tacair ina bhfuil ceithre rud (4).

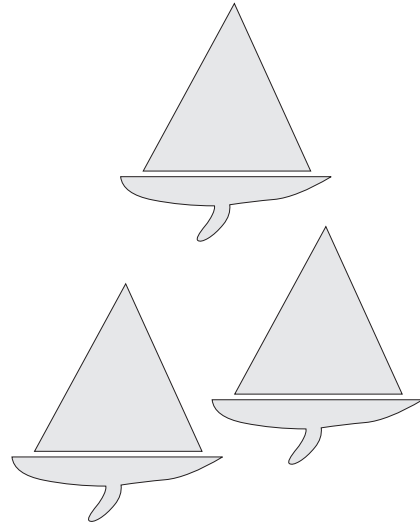
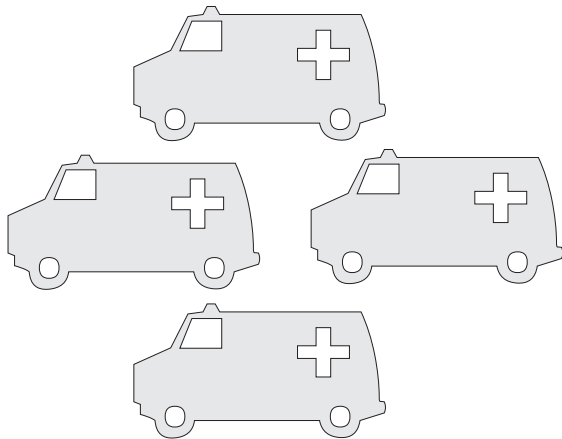
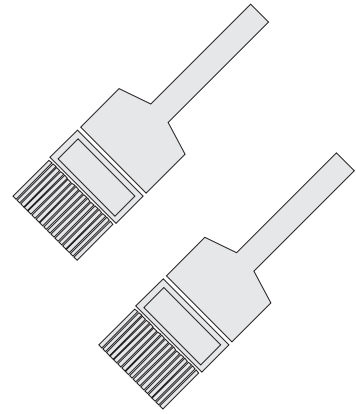
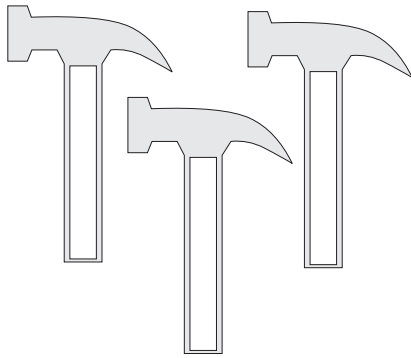

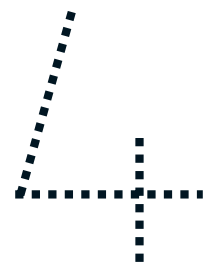
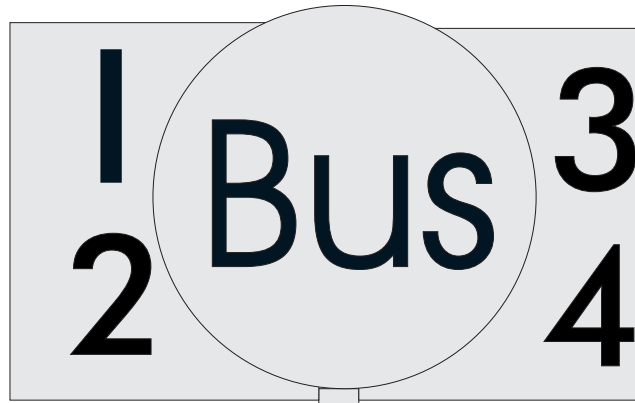



2

3

4

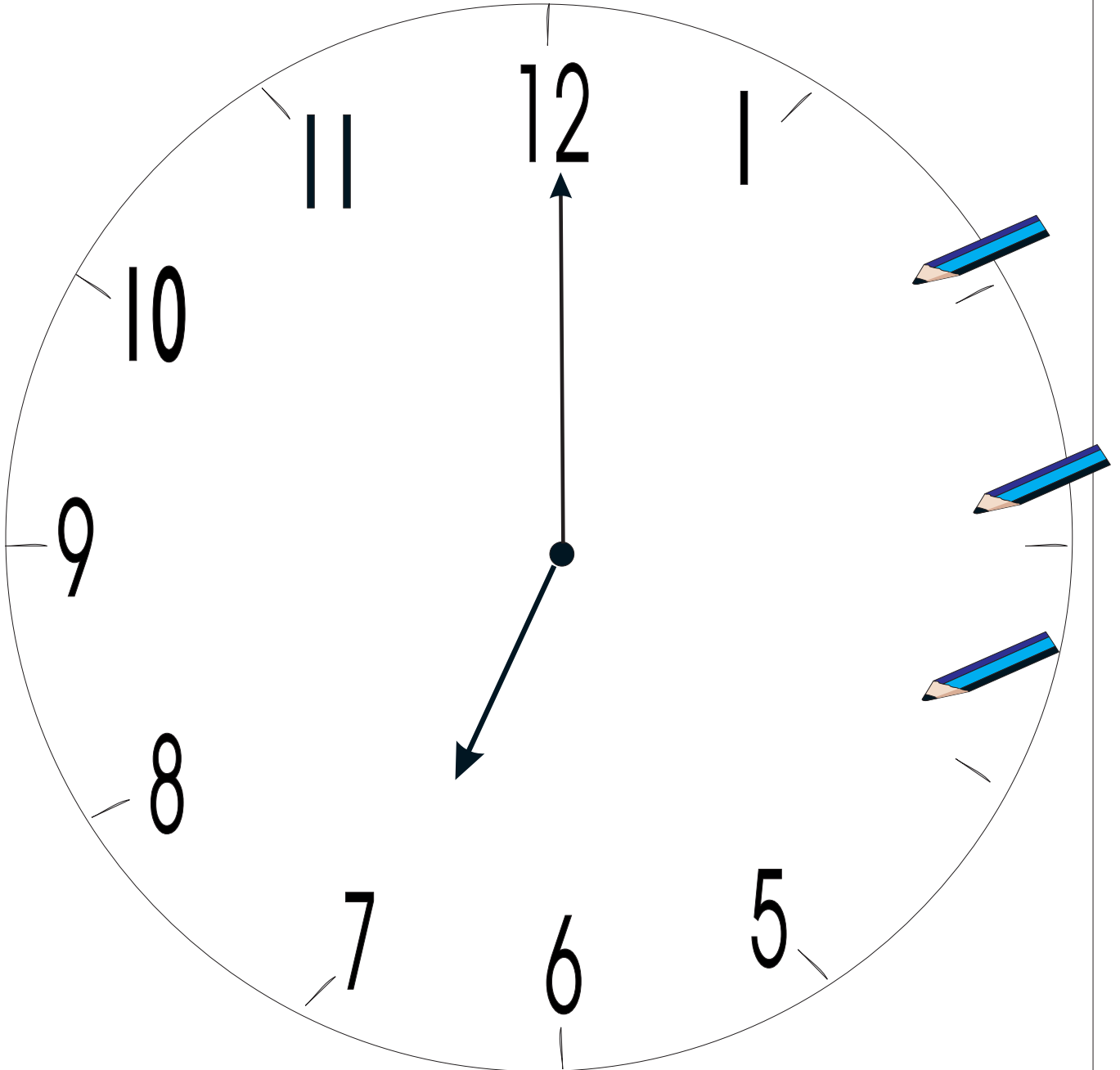

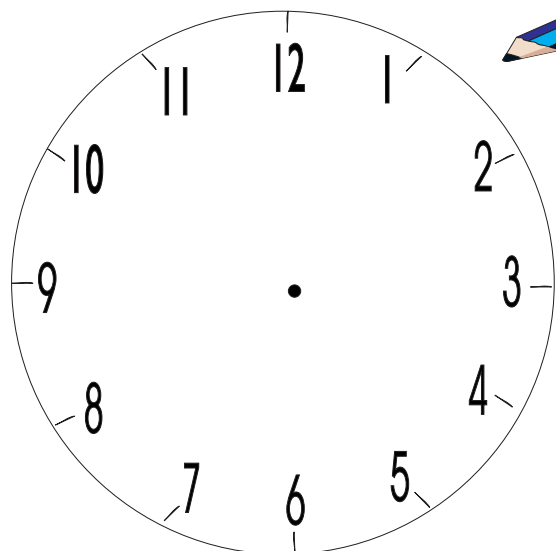

Am bricfeasta

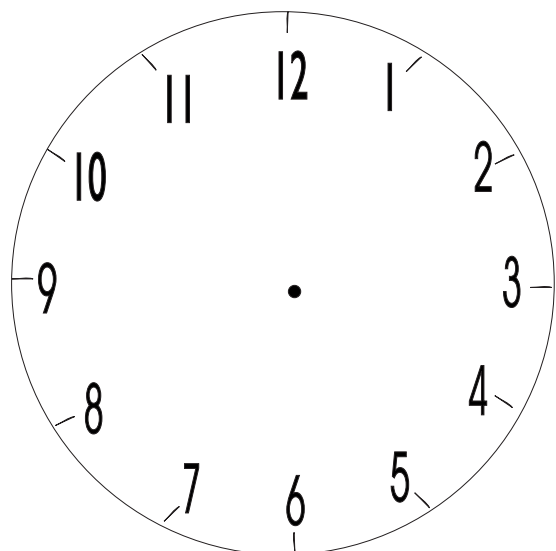

Am lóin

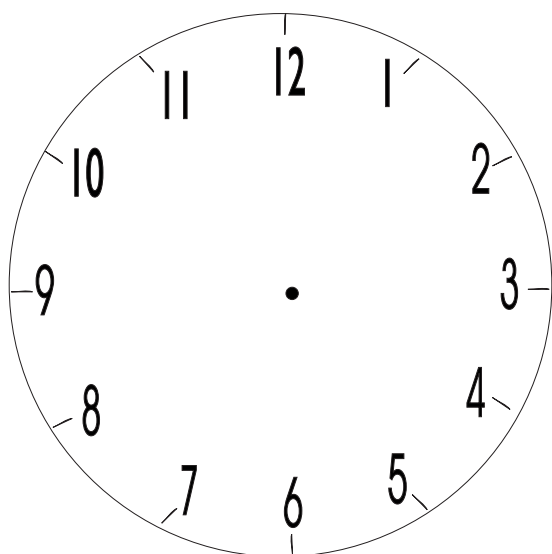

Am luí

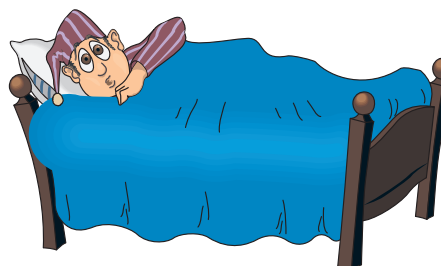

a Cúig

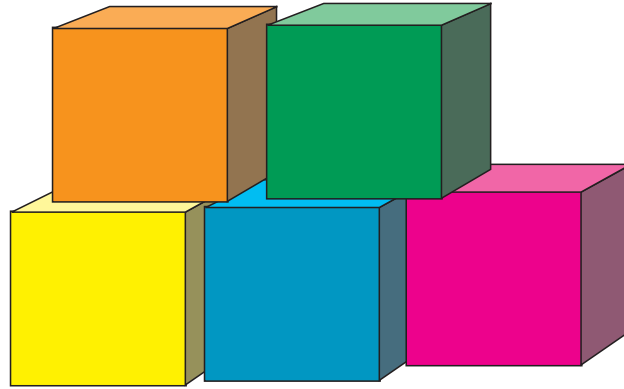

Cúig cinn



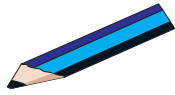

Ceangail an uimhir de na tacair chuí.

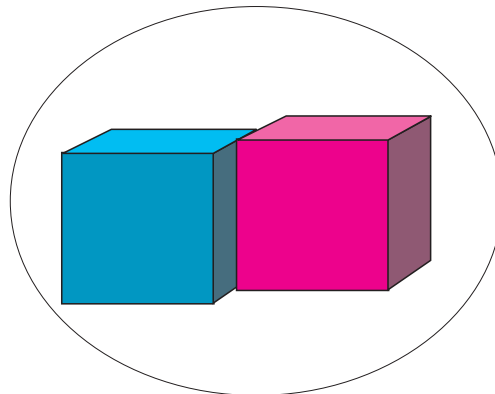
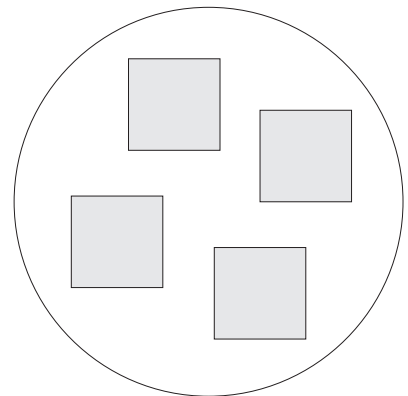
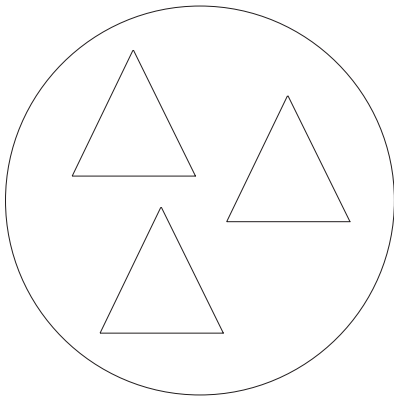
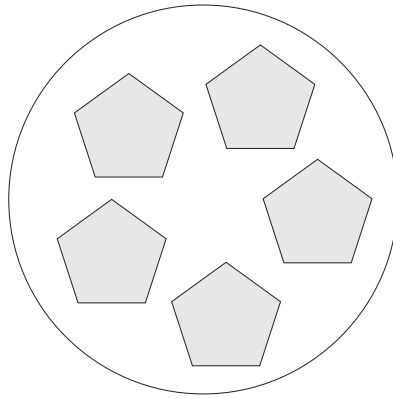
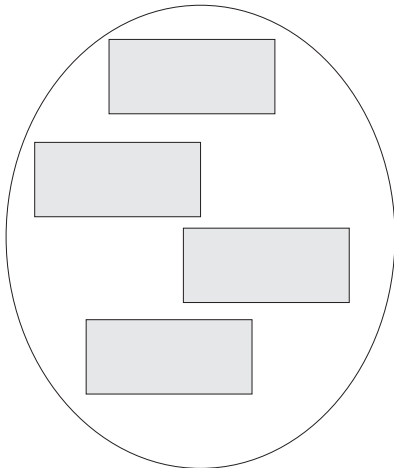



Meaitseáil iad seo.

1

2

2

3

3

4

4

1

5

5

5

5

5

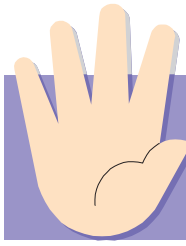

a Cúig

5

5

5

5

5

5

5

5

5

5

5

5

5

5

5

5

5

5

5

5

Cúig cinn

5

5

5

5

5

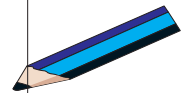
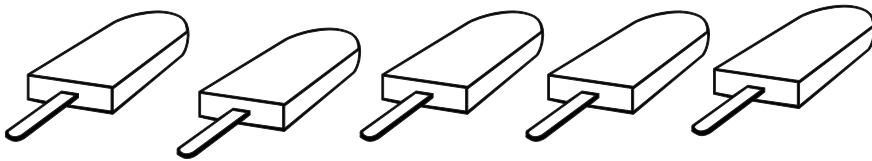
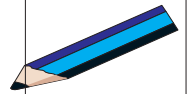
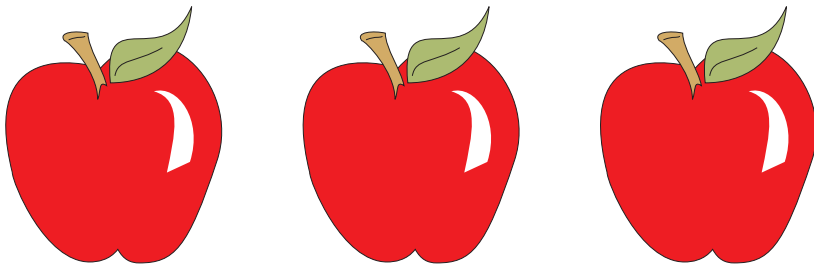
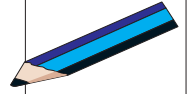
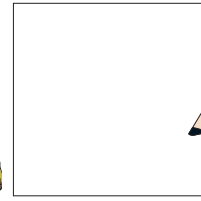
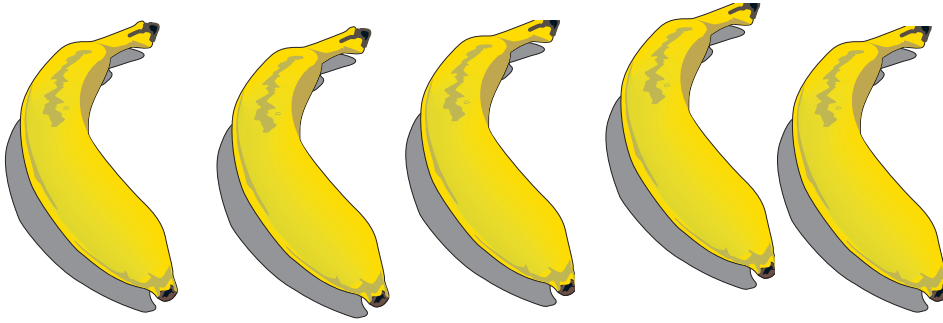

a Cúig



Cúig cinn





1

2

3

4

5

Scríobh uimhir i ngach cruth.

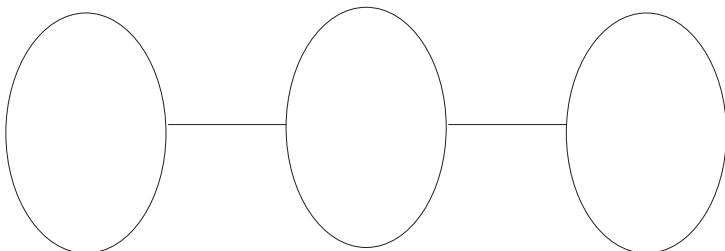
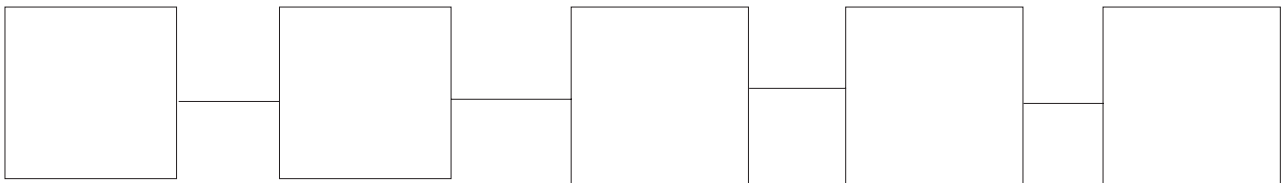
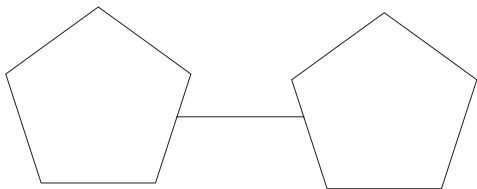
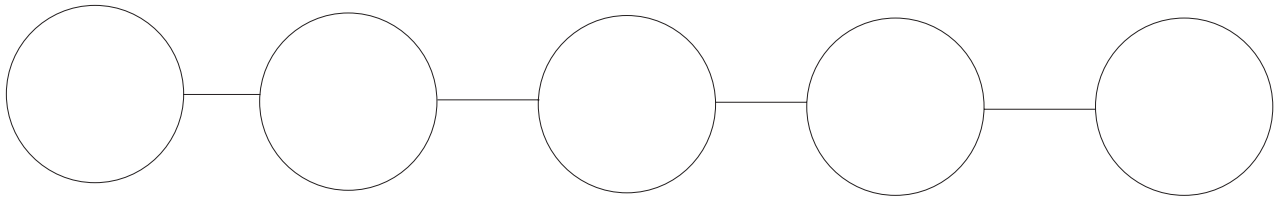
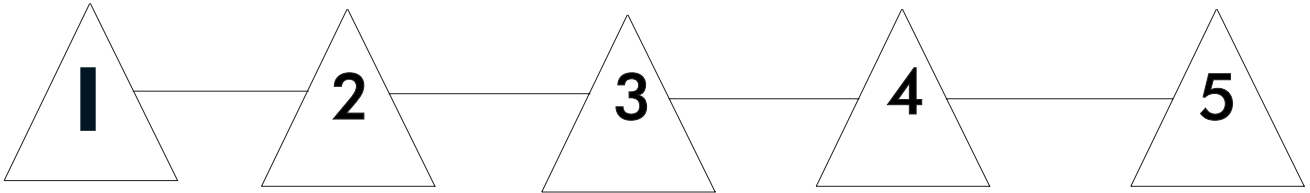

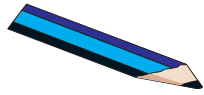

Dhá shúil (2)



Tarraing líne timpeall ar na rudaí boga.

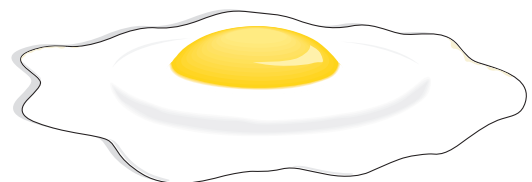
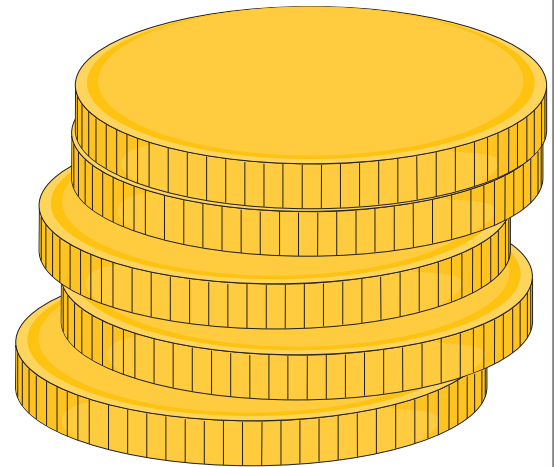
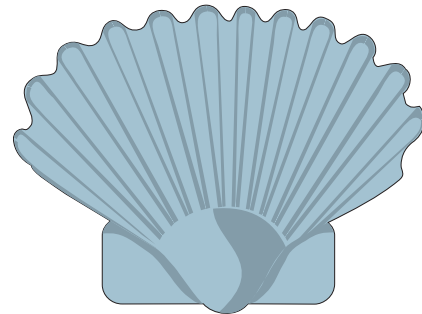
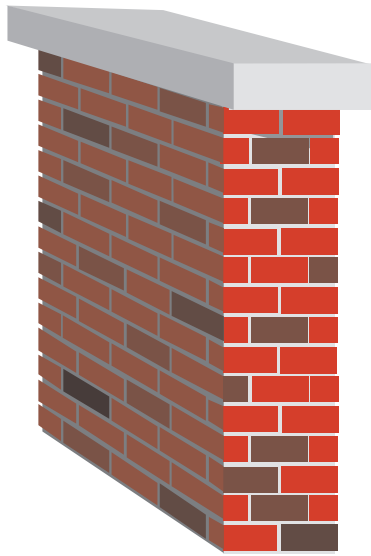

Meaitseáil iad seo agus dathaigh iad.

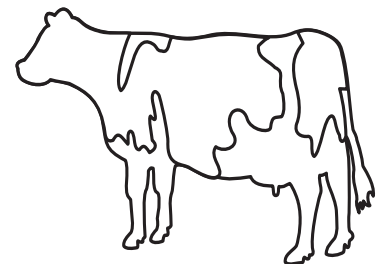
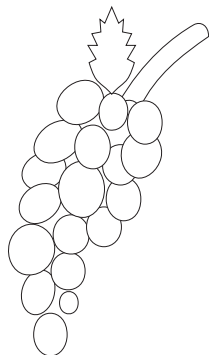
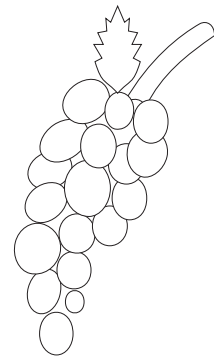
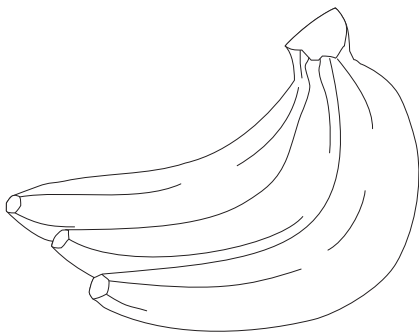
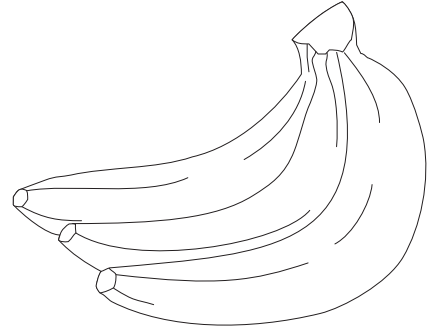
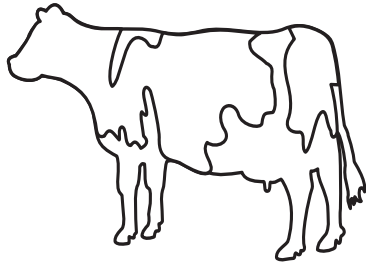

Cuir líne timpeall ar na rudaí adhmaid.

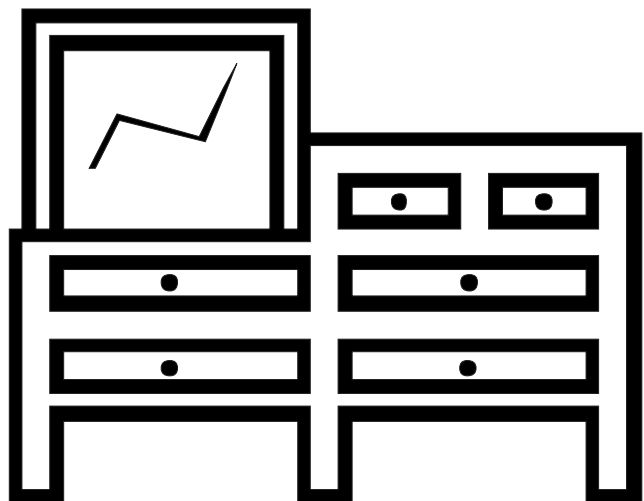
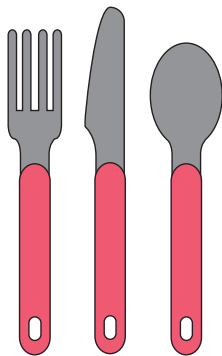
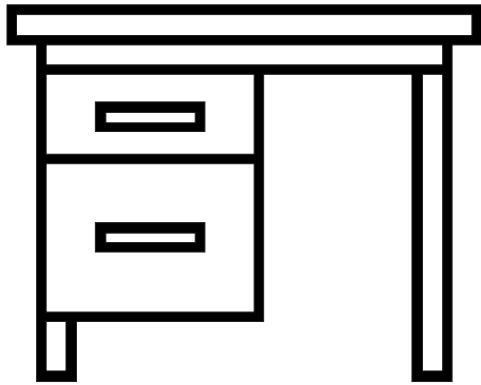
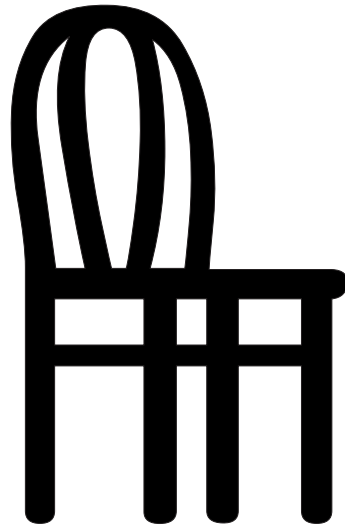
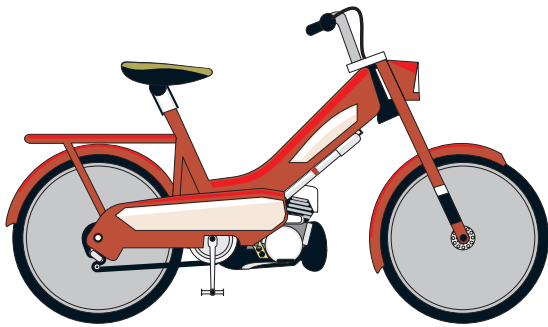

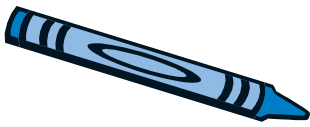

Cén t-ainmhí is airde?

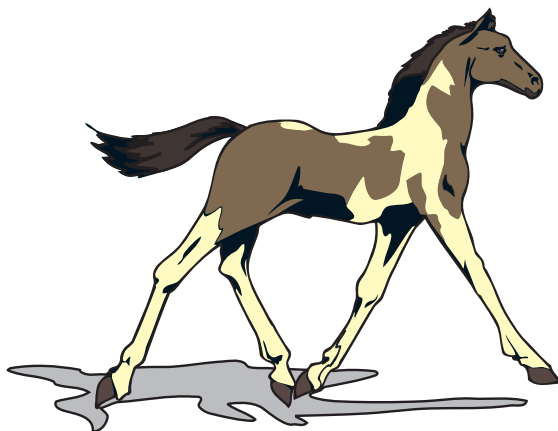
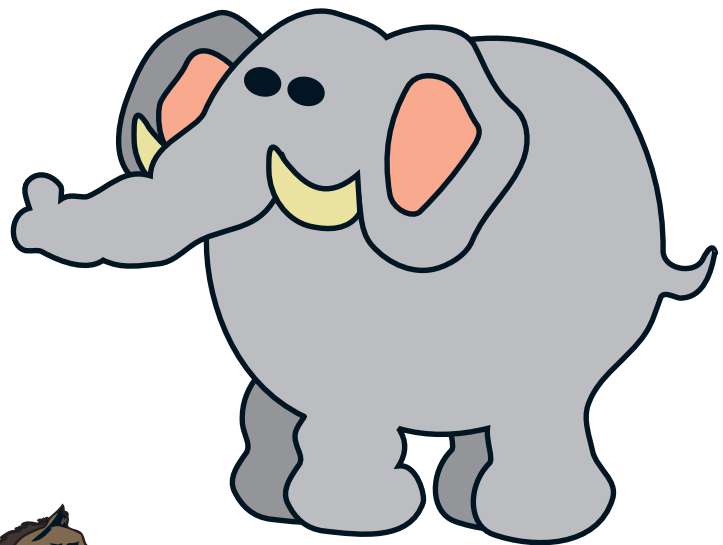
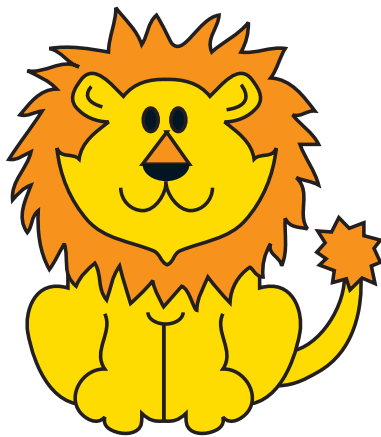
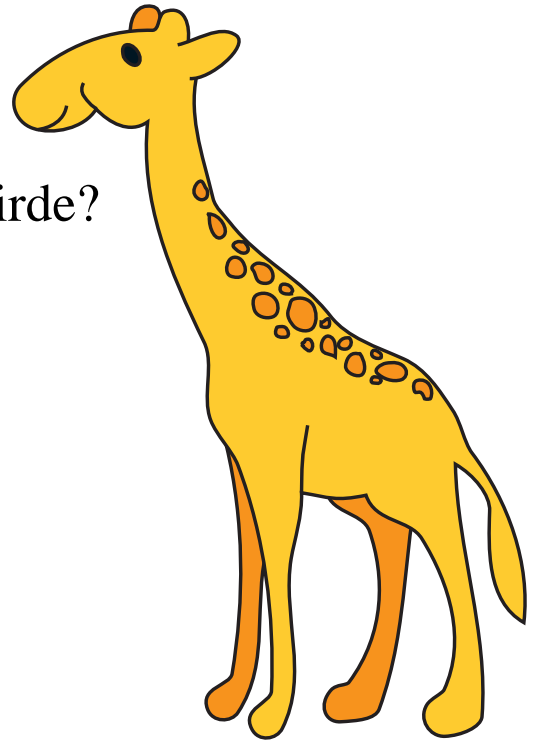



Meaitseáil iad seo.

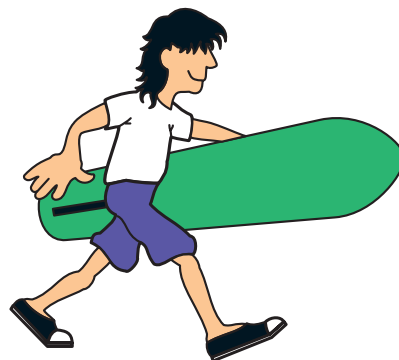
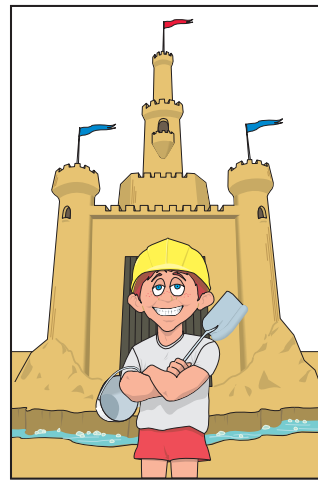
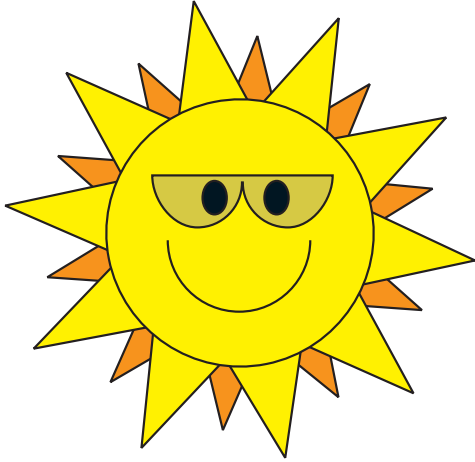



1ú

An chéad áit



2ú

An dara háit



3ú

An tríú háit



Tá an teidí ar an ___ú céim.



Tá an liathróid ar an ___ú céim.



Tá an carr ar an ___ú céim.

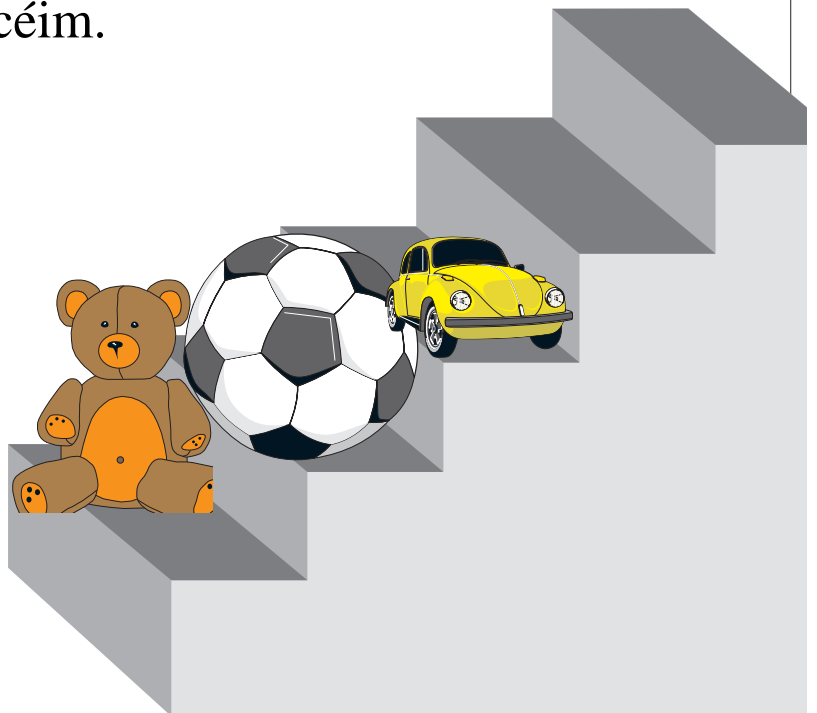



1ú



2ú

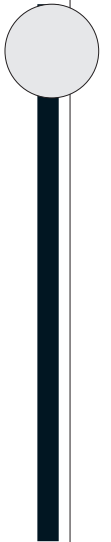

Sa chéad áit

Sa dara háit

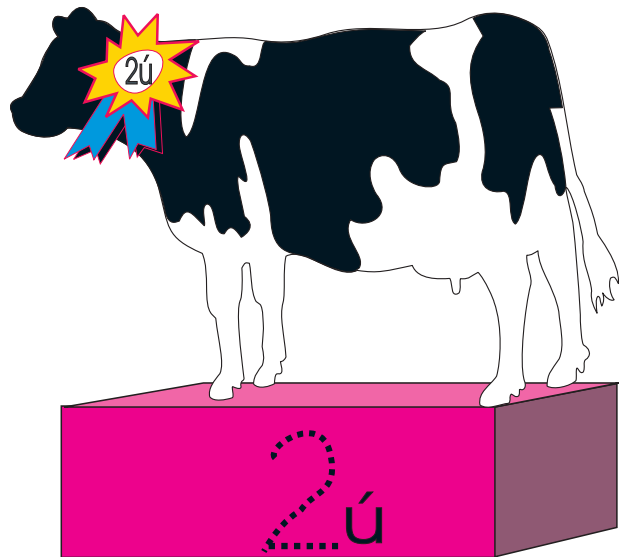
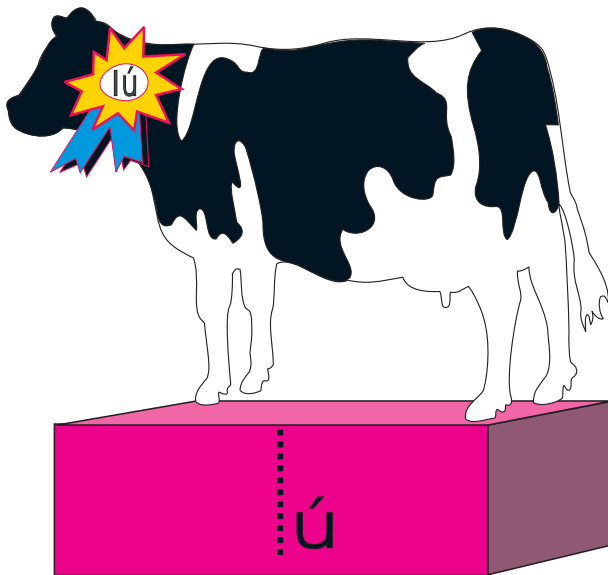

An chéad duais

An dara duais

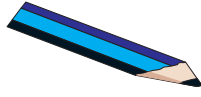

Meaitseáil iad seo.

5

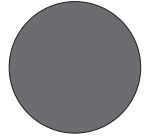

4

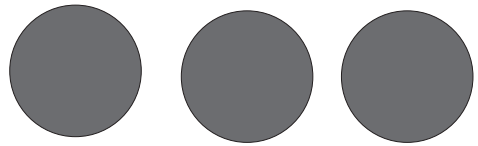

3

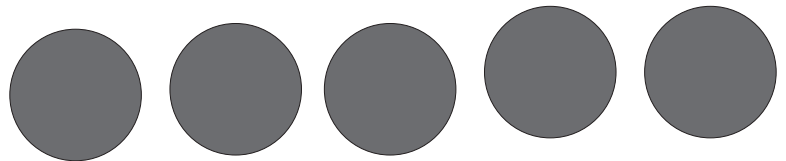

2

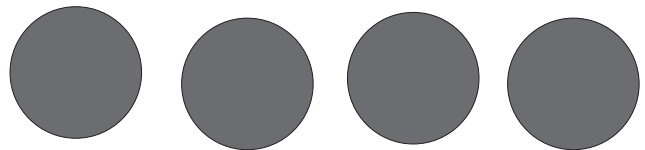

1

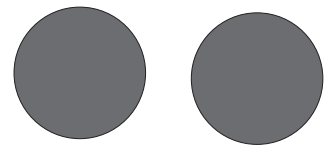

Cuir ✓ leis na rudaí atá te.

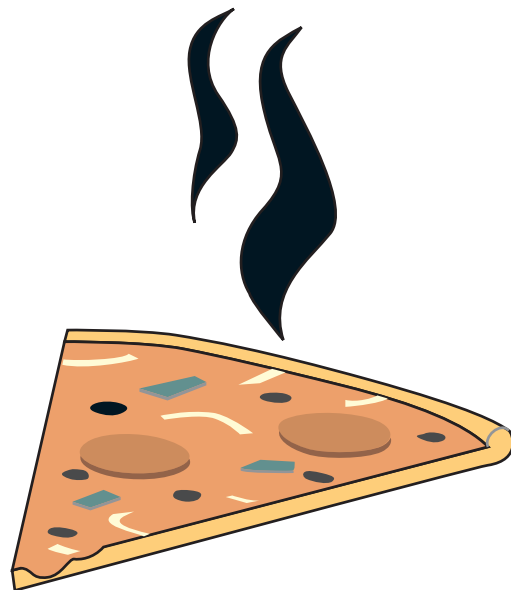

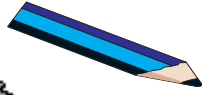

Meaitseáil iad seo.

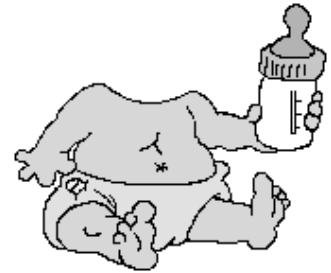

éadrom

trom

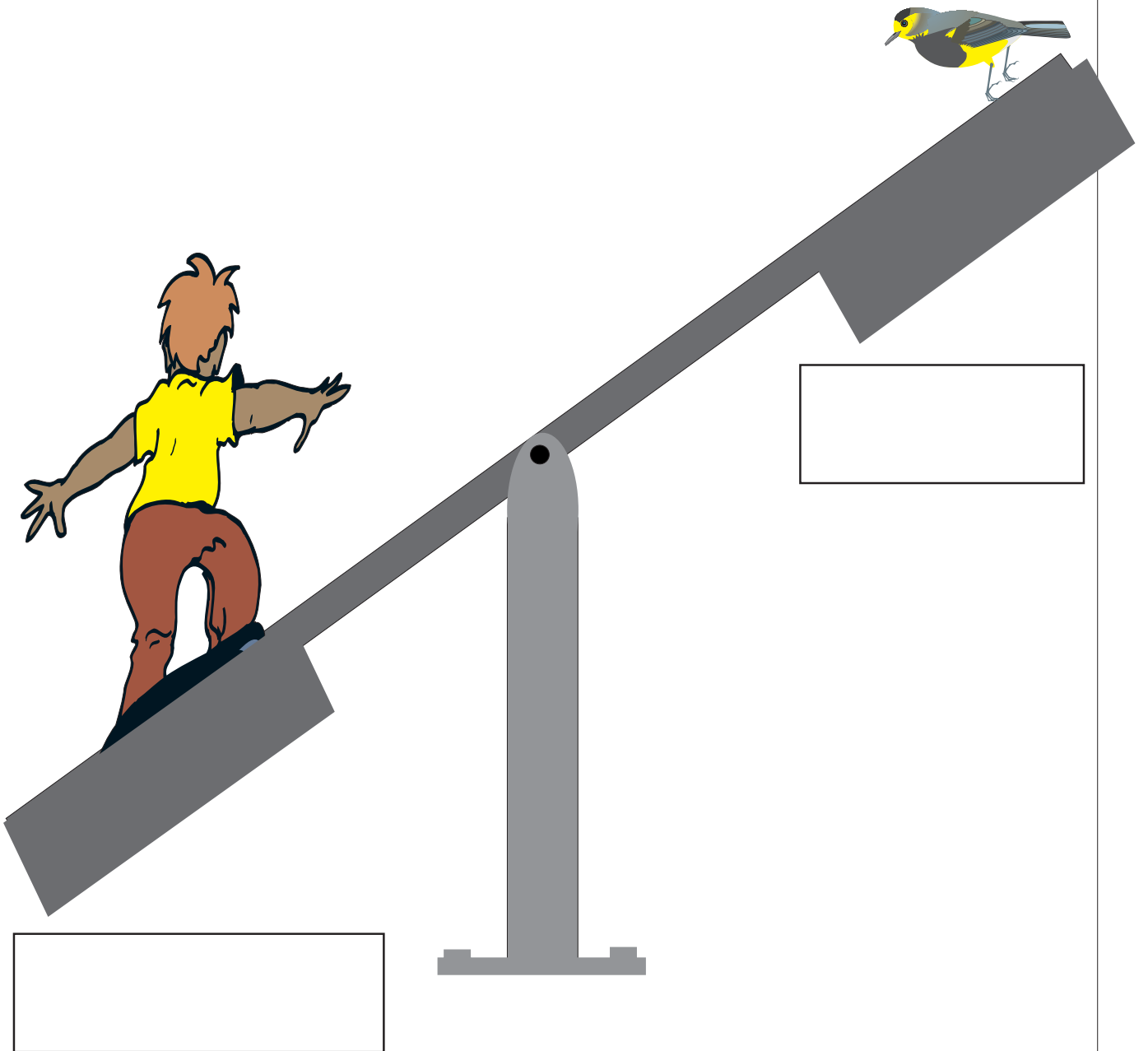

Ceangail na bláthanna den phota.
Agus na torthaí den bhabhla.

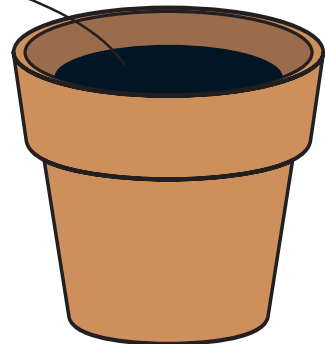
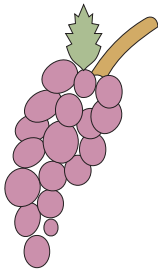
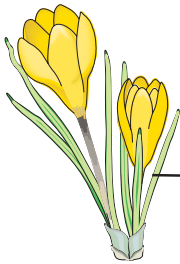
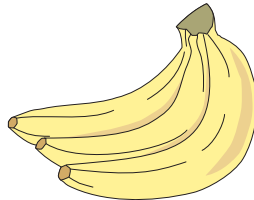
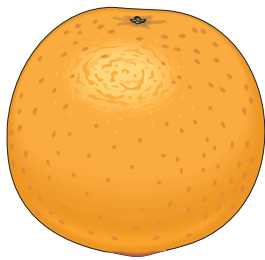
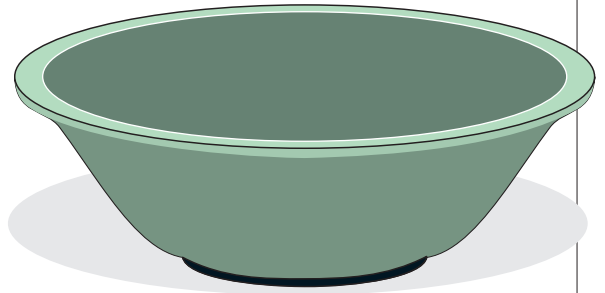
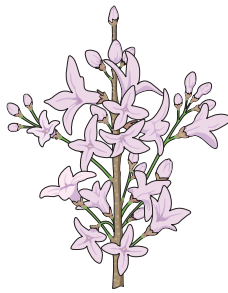
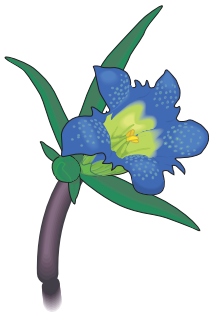
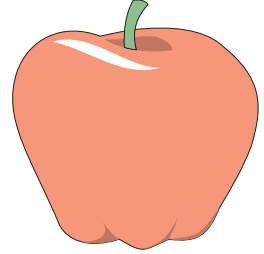
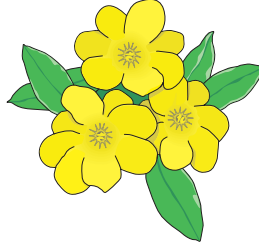
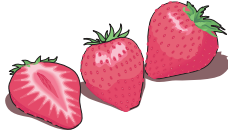

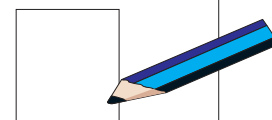
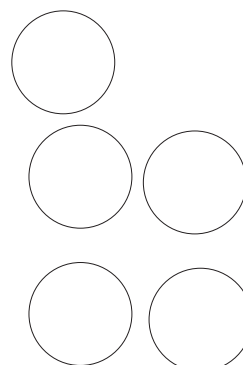
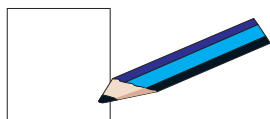
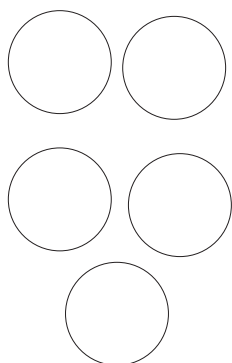
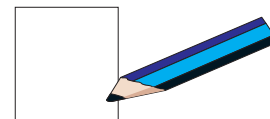
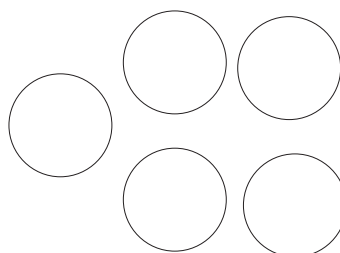
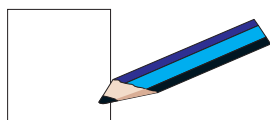
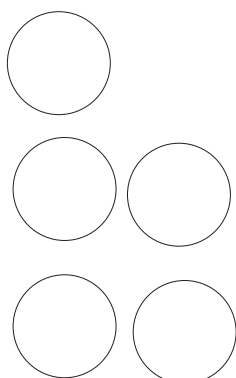
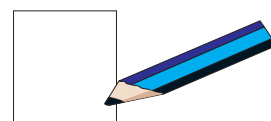
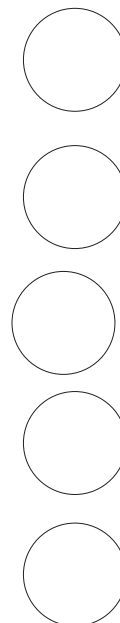
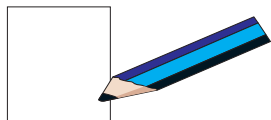
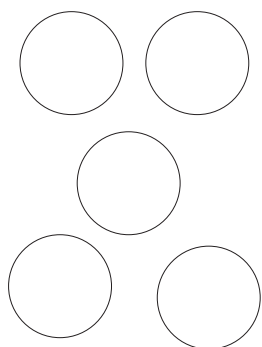

Scríobh an uimhir ceart i ngach bosca.

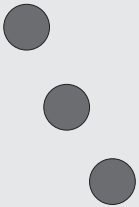

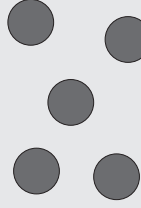
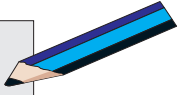
	3
---	----------

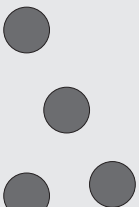
	
--	---

	
---	--

	
--	--

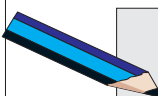
	2
--	----------

	4
--	----------

	1
--	----------

	5
--	----------

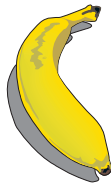
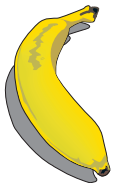

1 agus 1 =

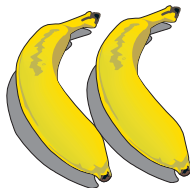
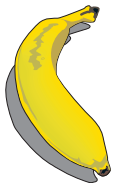
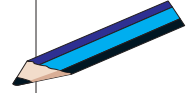
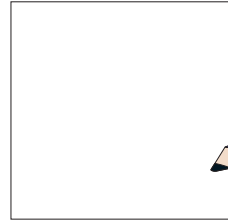

1 agus 2 =

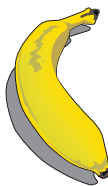
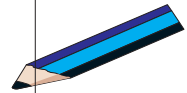
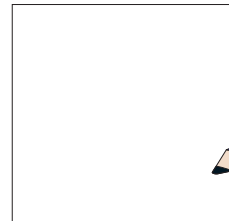

2 agus 1 =

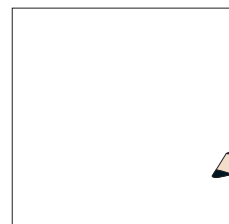

2 agus 2 =

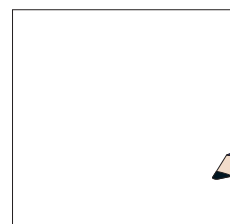



3 agus 1 =

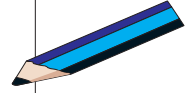

3 agus 2 =

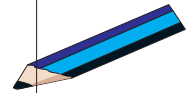

2 agus 2 =



2 agus 3 =



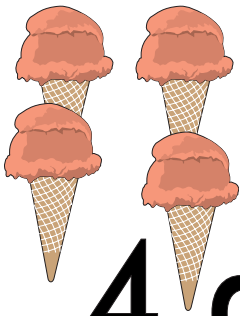

4 agus 1 =

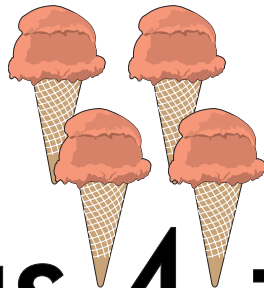
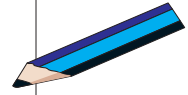

1 agus 4 =

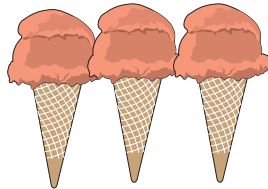
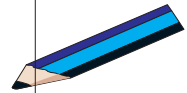

2 agus 3 =



2 agus 0 =





4 agus 0 =

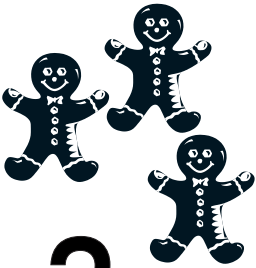
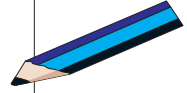

3 agus 0 =



0 agus 1 =

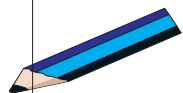

0 agus 2 =



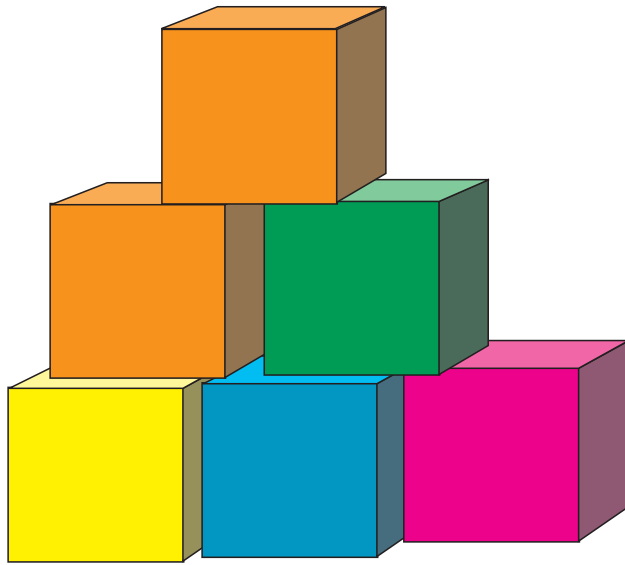

6
a Sé

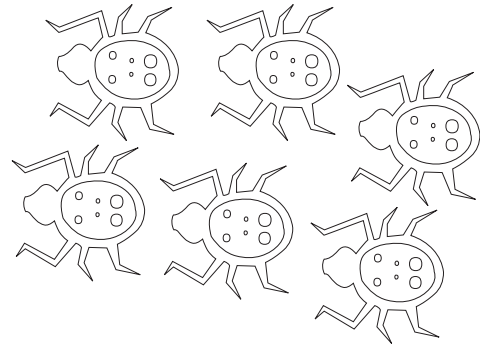
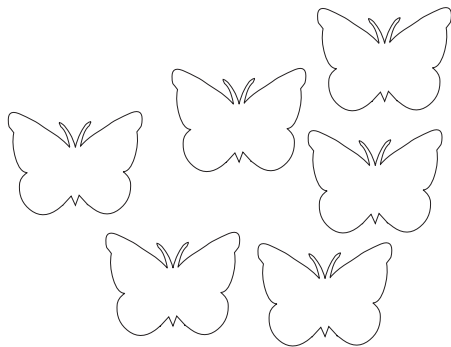

Sé cinn

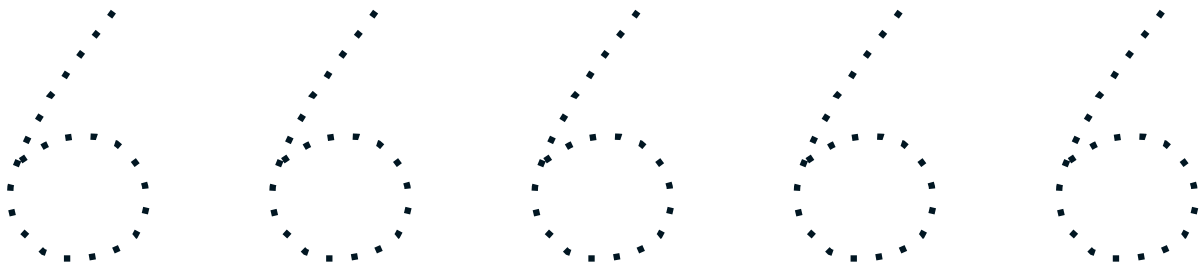

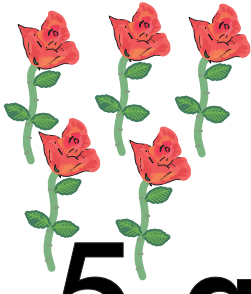

5 agus 1 =

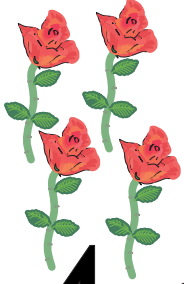
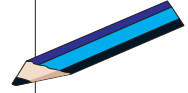

4 agus 2 =



3 agus 3 =

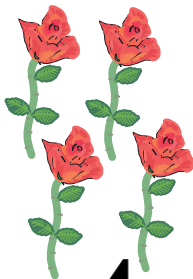

2 agus 4 =





5 agus 0 =

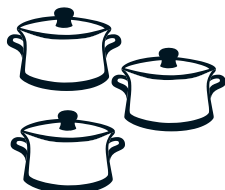
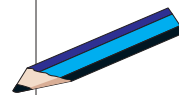

3 agus 2 =



2 agus 4 =

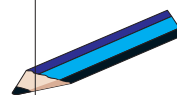

2 agus 3 =



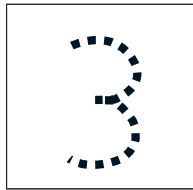

agus

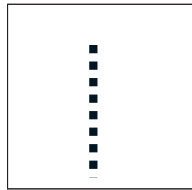

=

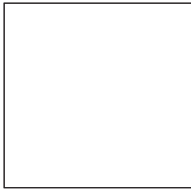
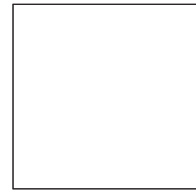

agus

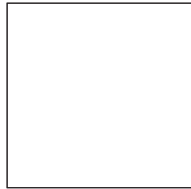

=

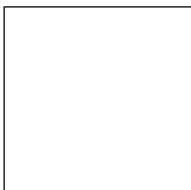
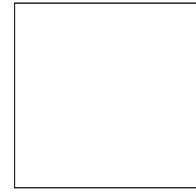

agus



=

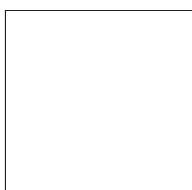

agus

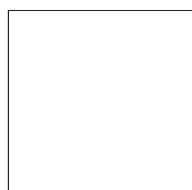

=

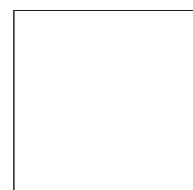

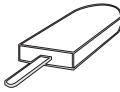
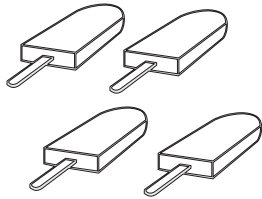
 
 agus =

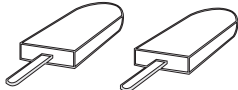
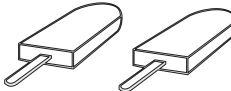
 
 agus =

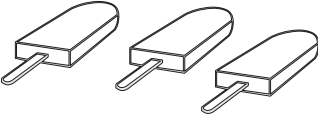
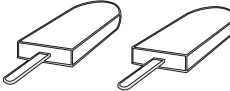
 
 agus =

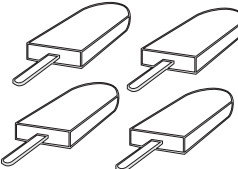
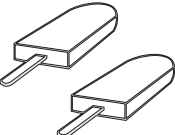
 
 agus =

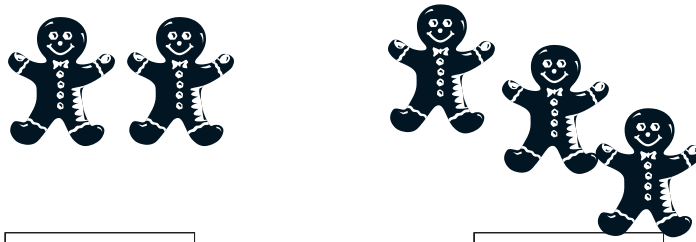

agus

=

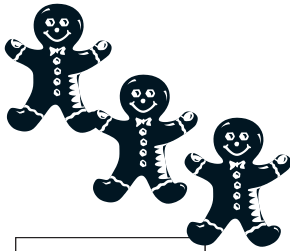

agus

=

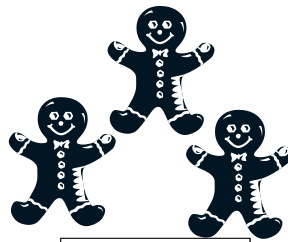

agus

=

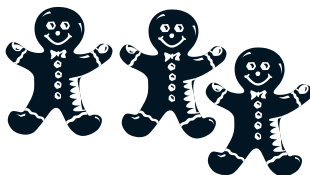



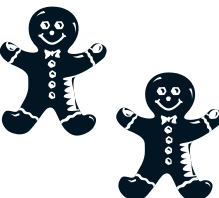

agus

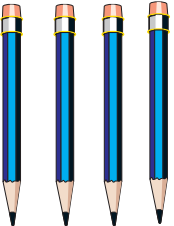
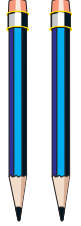

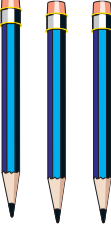
=

 agus  =

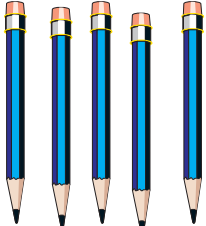
 agus  =

 agus  =

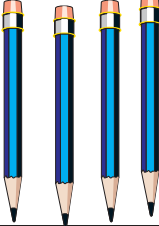
 agus  =

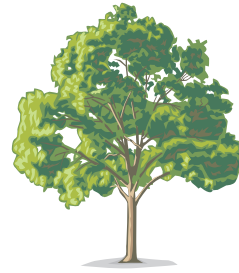
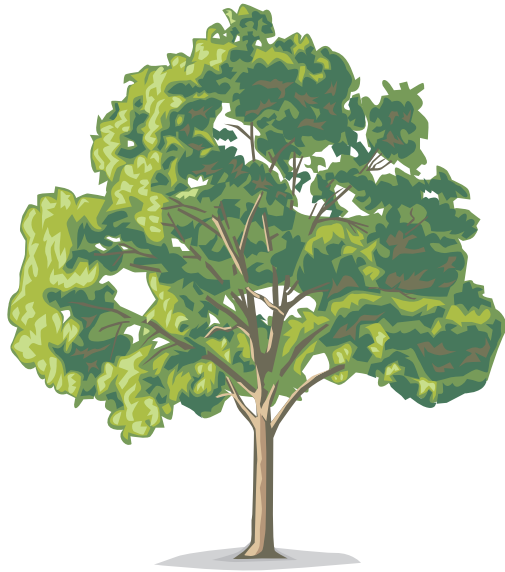

Mór

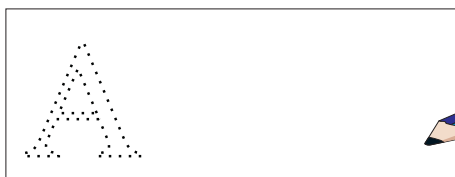
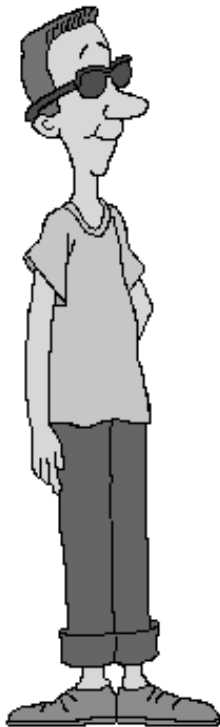

Íseal



sean



óg

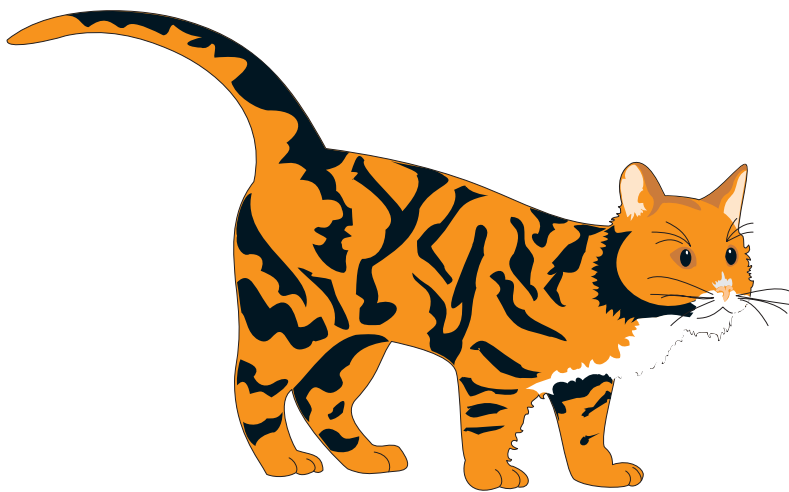
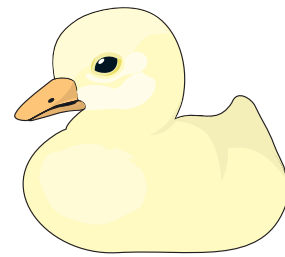
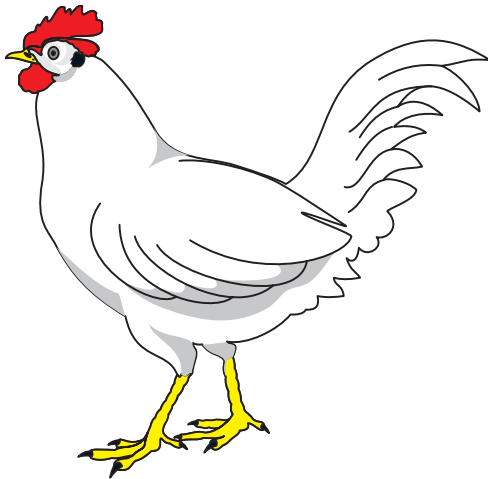

Naíonáin Sinsir

Meaitseáil iad seo. 

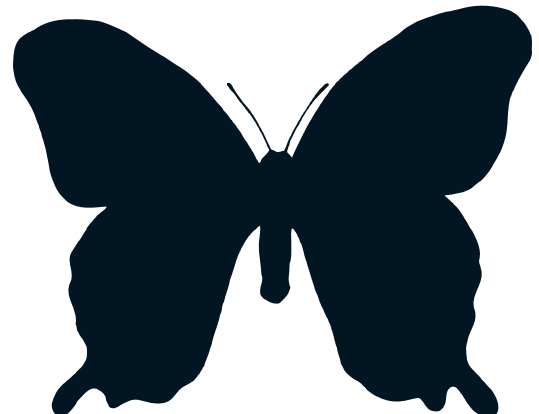
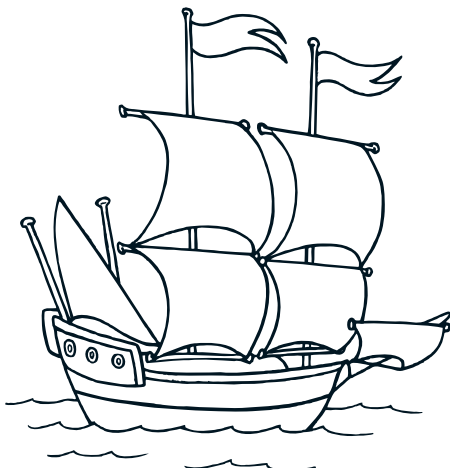
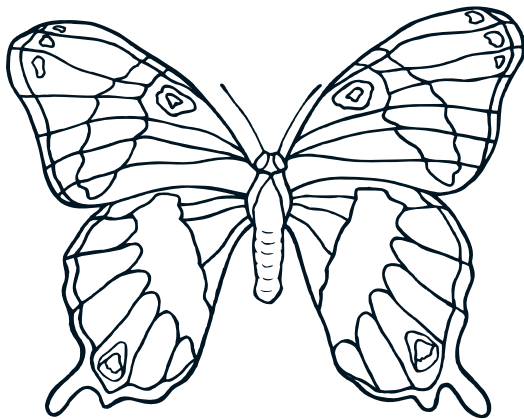

a Dó

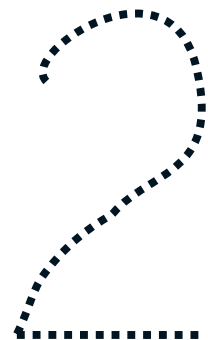
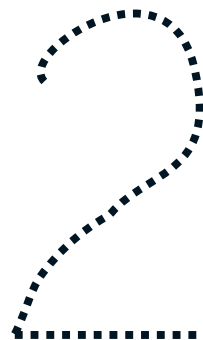
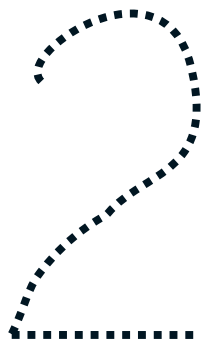
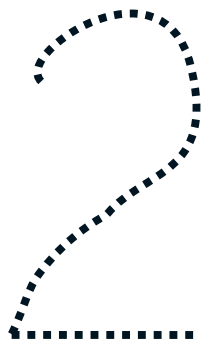
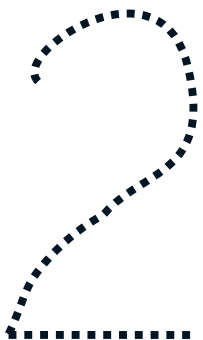
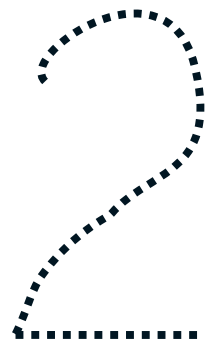
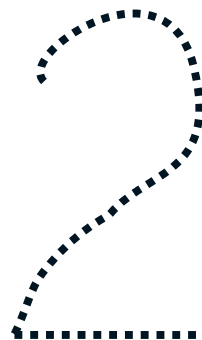
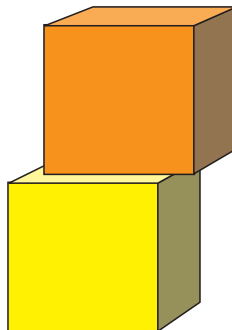
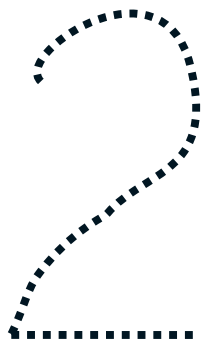
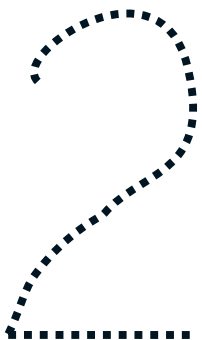
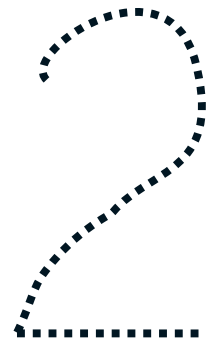
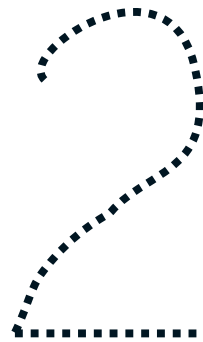
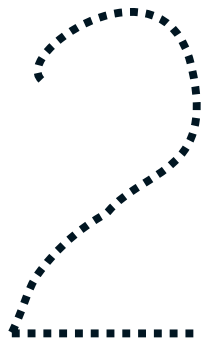
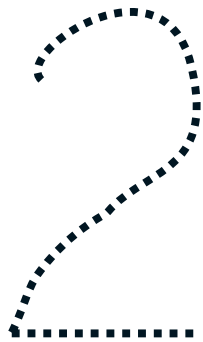
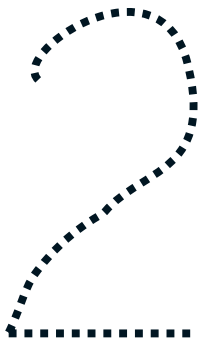
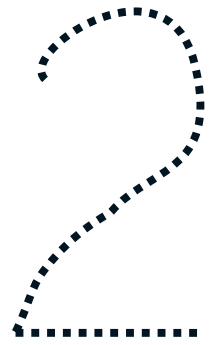
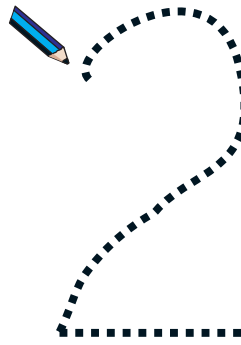

a Trí

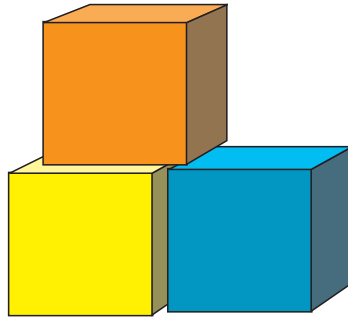

a Ceathair

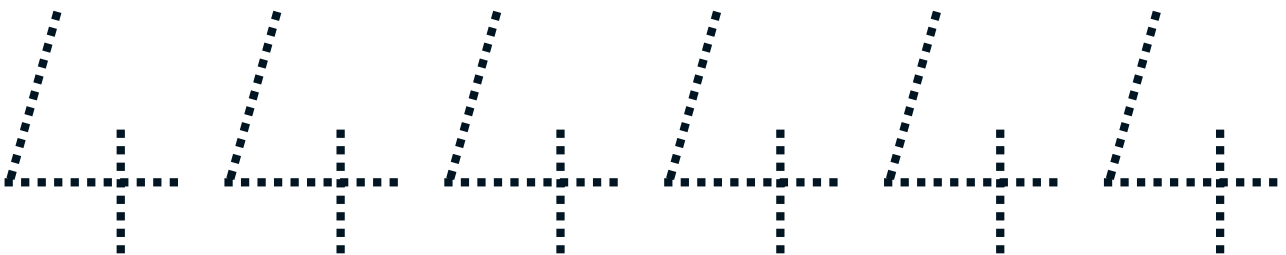
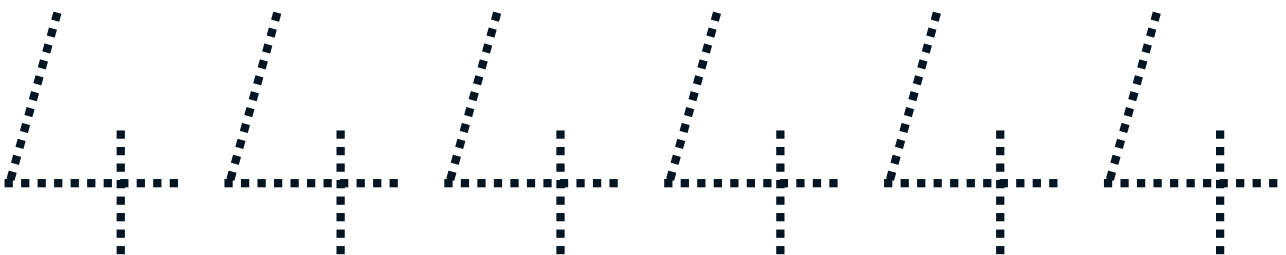
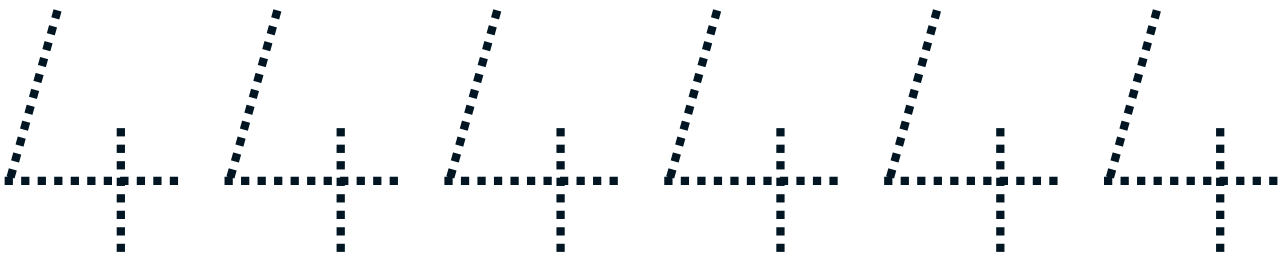
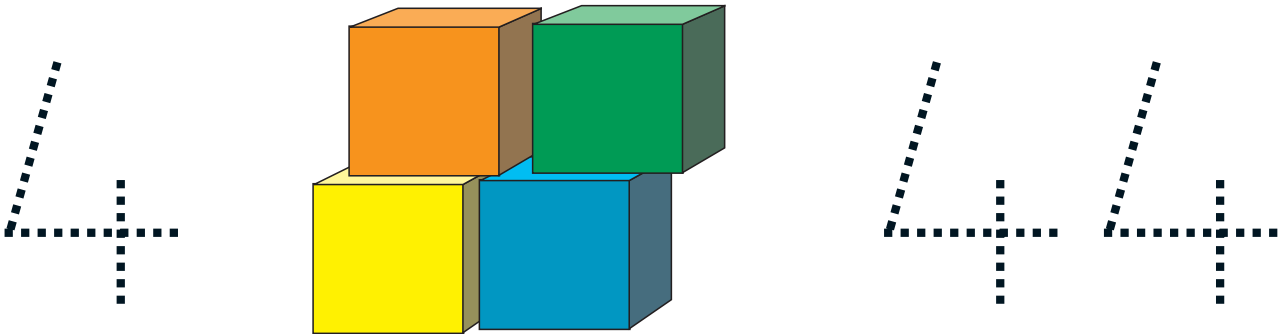
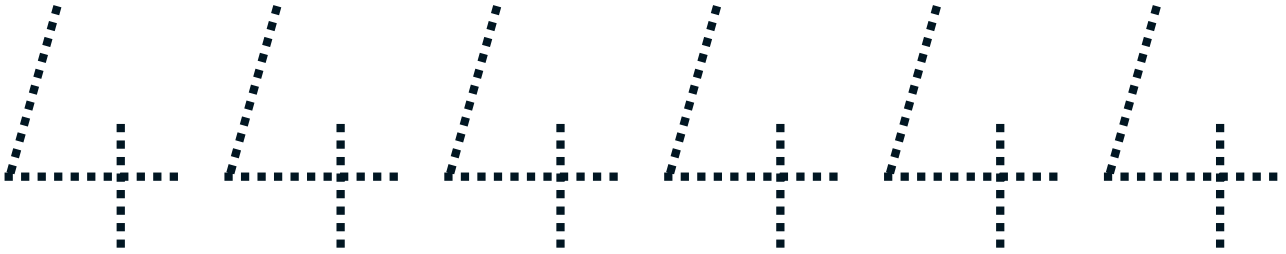
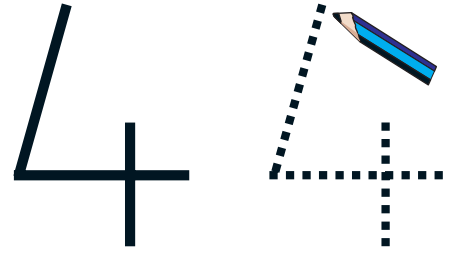

a Cúig

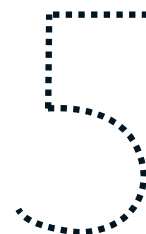
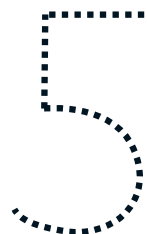
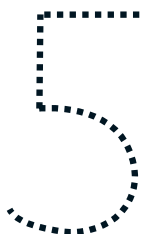
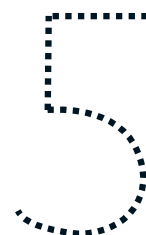
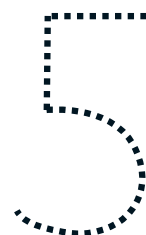
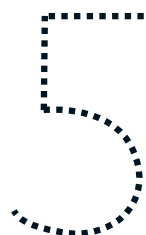
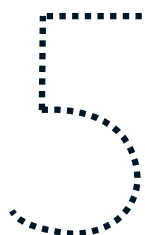
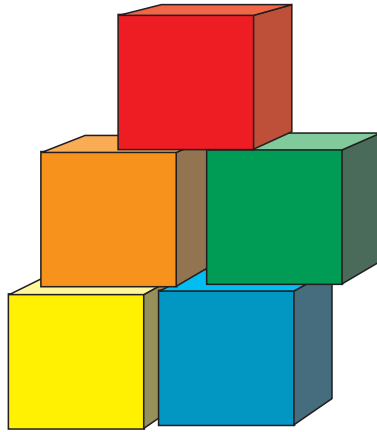
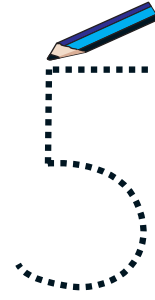

Meaitseáil iad seo.

1

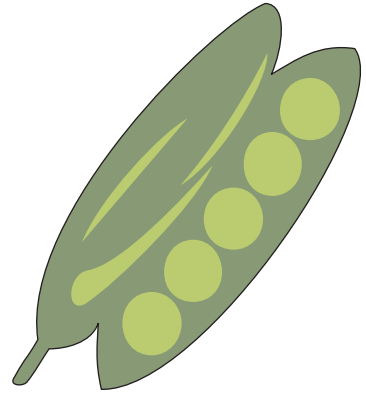

2



3



4

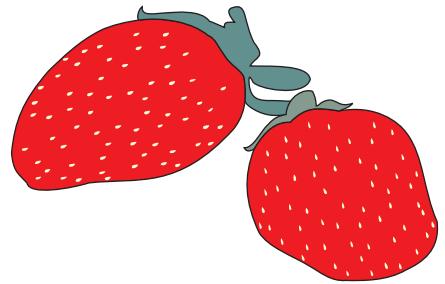

5

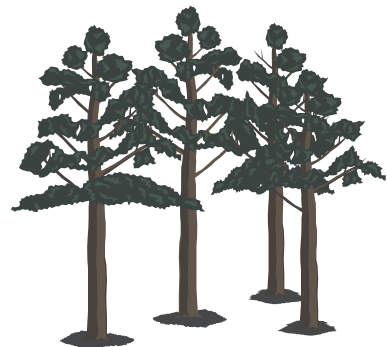

Meaitseáil iad seo.

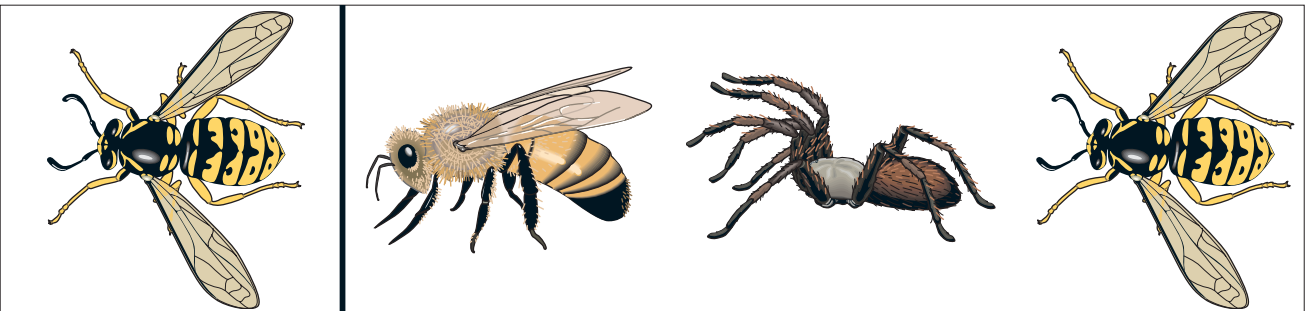
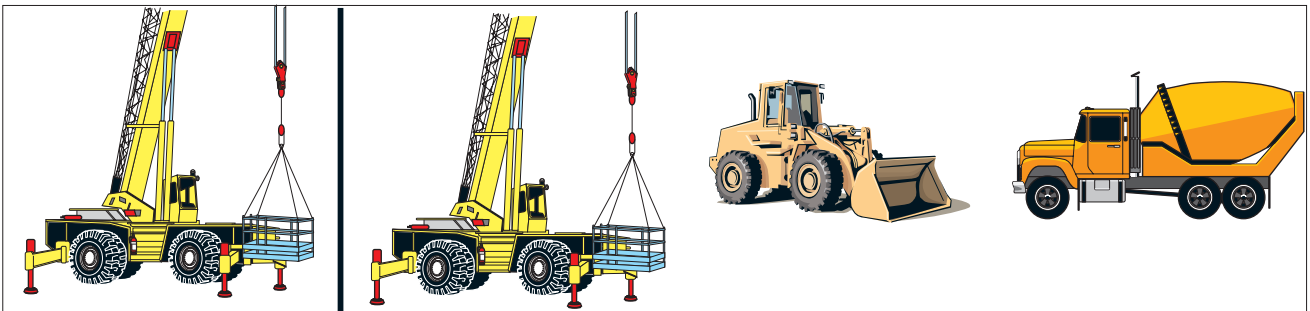
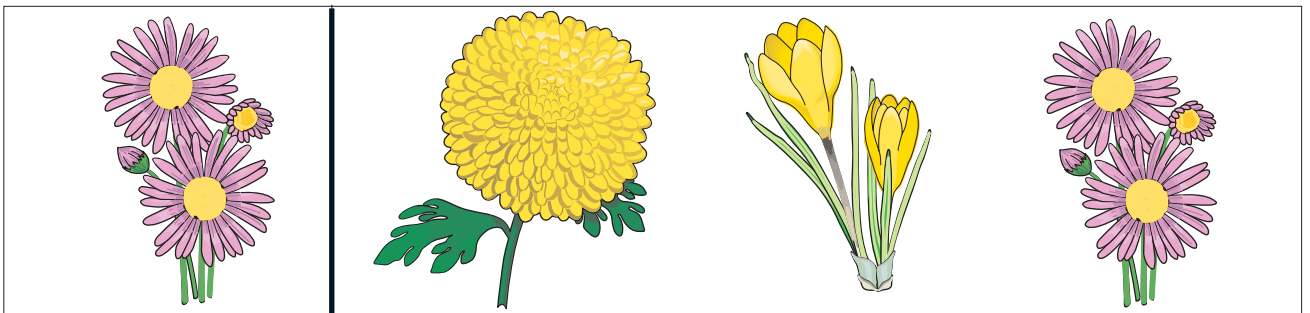
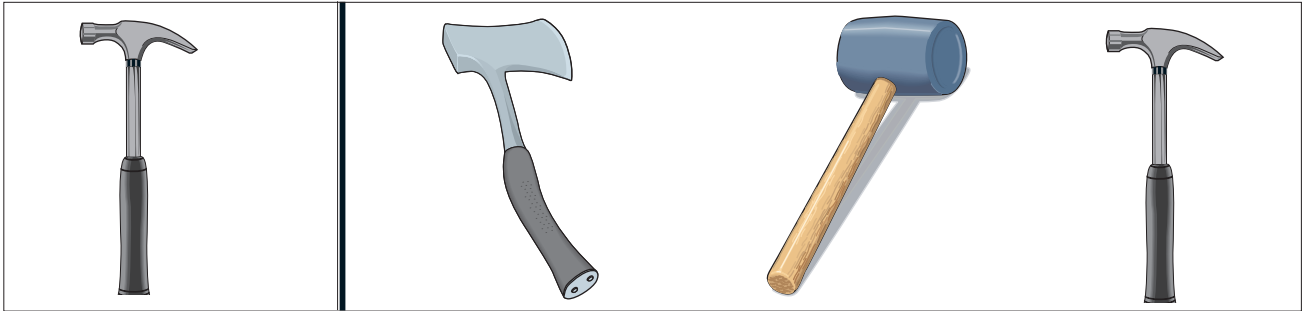
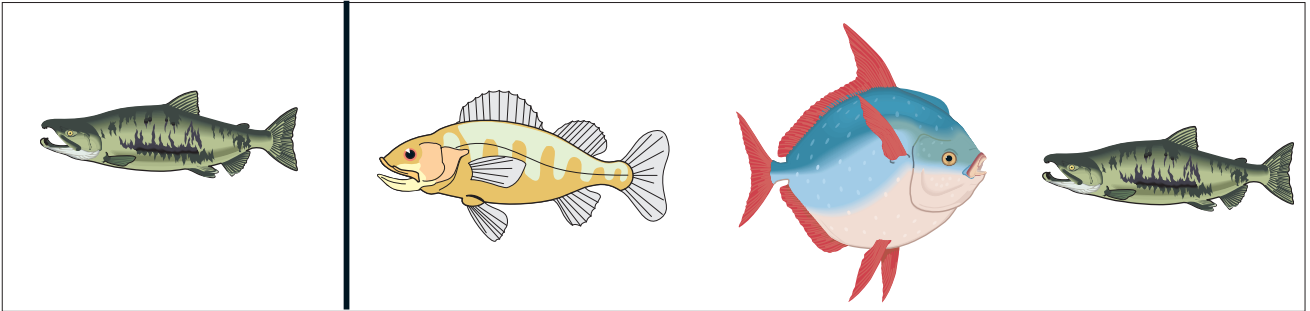

Meaitseáil iad seo.

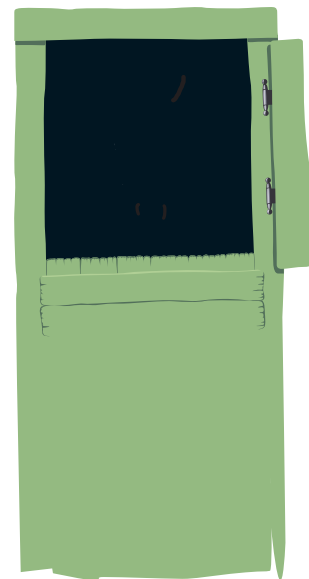
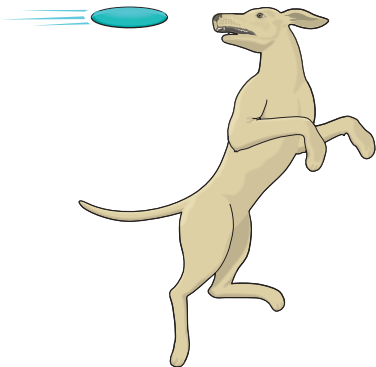
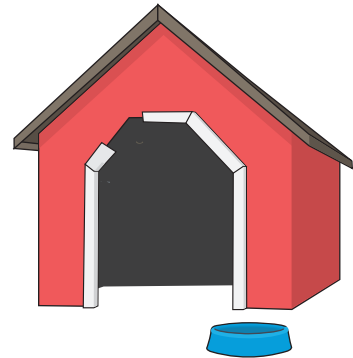
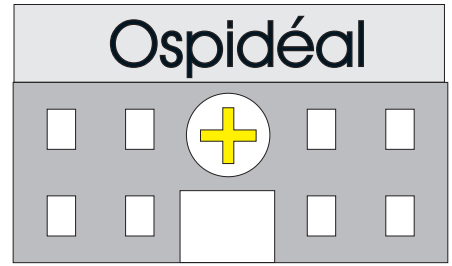
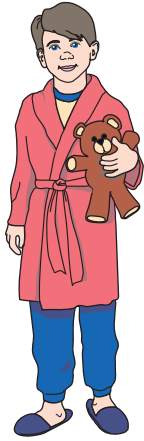

Cuir ✓ leis na cinn atá in ann eitilt.

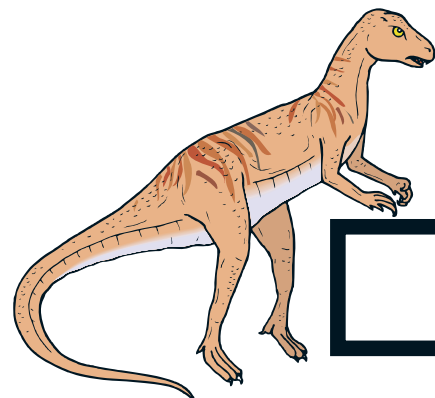
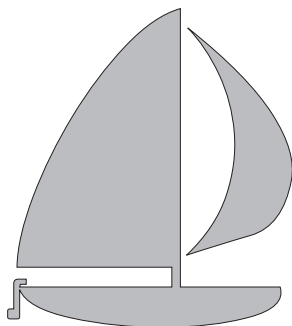
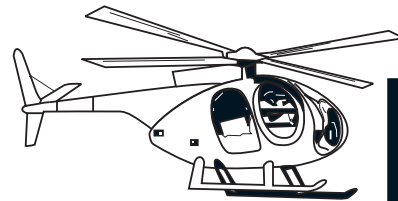
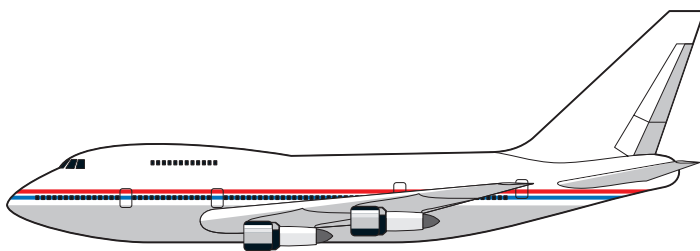
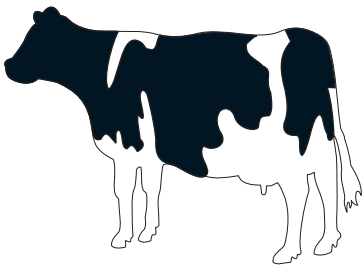

Tarraing línte ó na héadaí go dtí an ciseán.

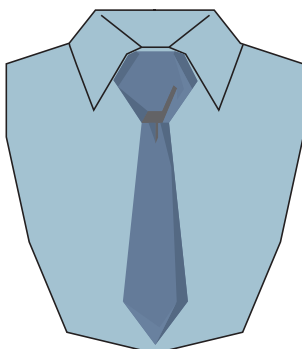
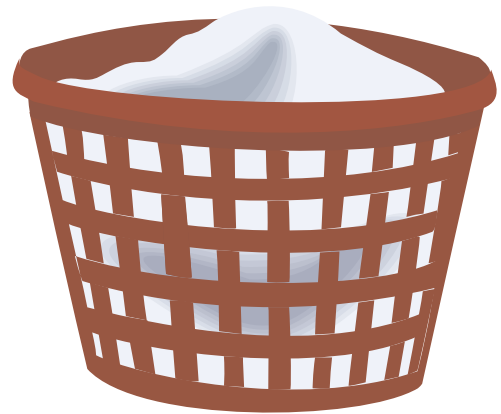
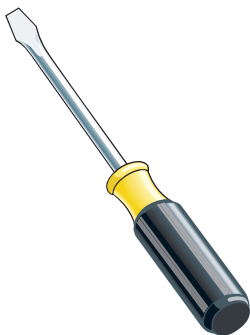
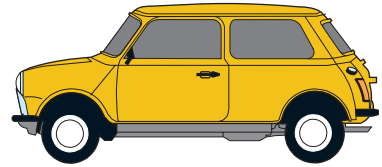

Ceangail ina bpéirí iad.

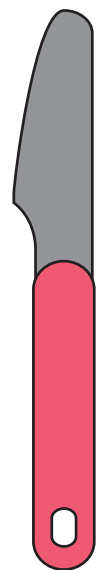
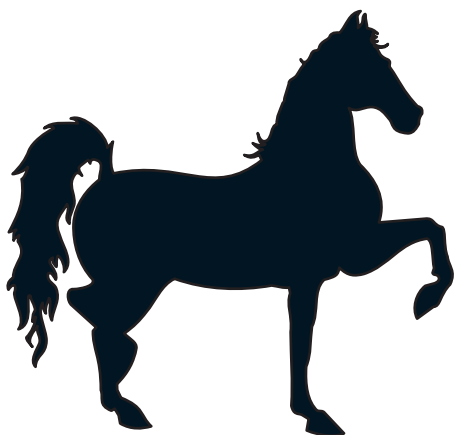
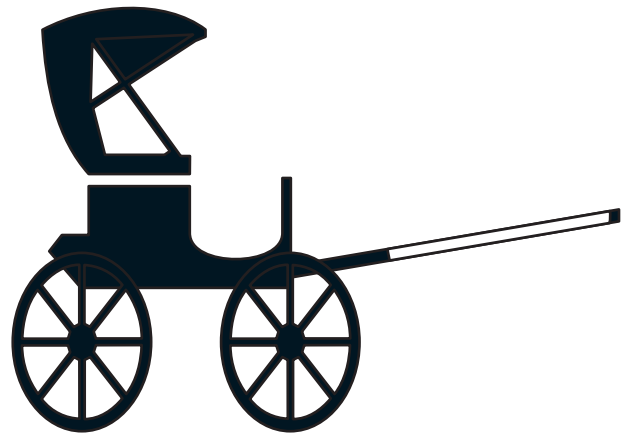
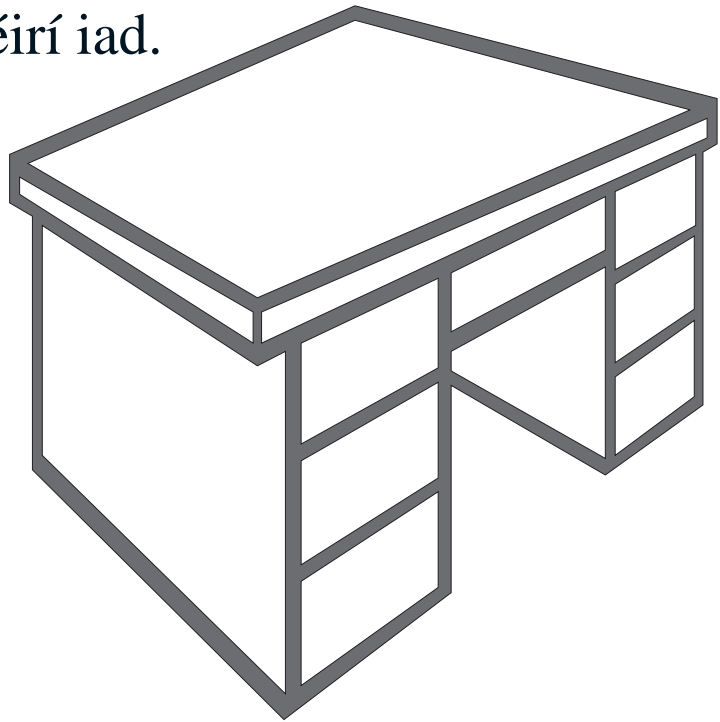
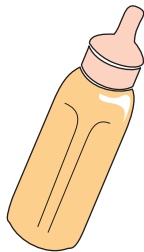
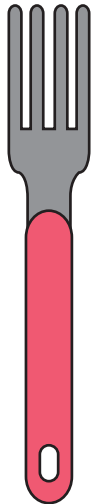

Tarraing an líon ceart úll i ngach bosca.

4

2

3

5

Scríobh síos an uimhir.

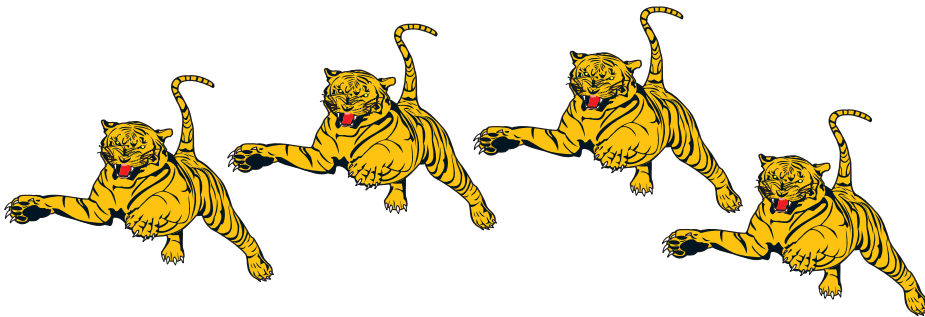
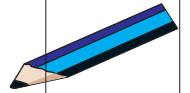
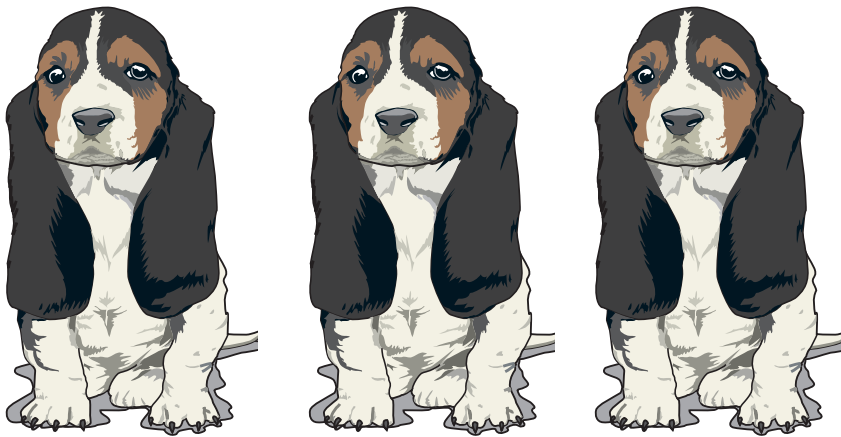
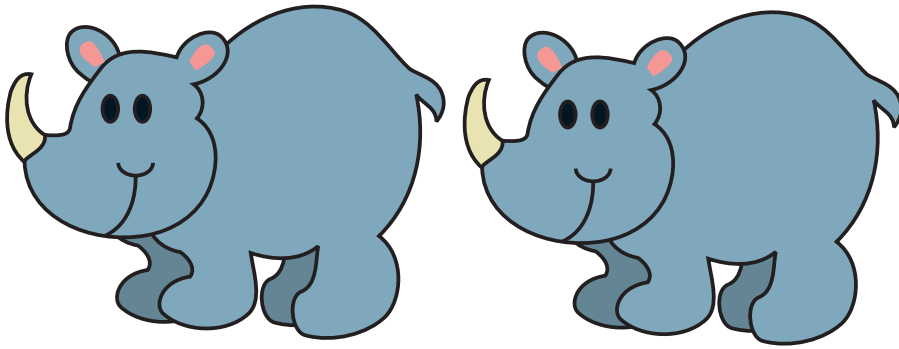

Scríobh síos an uimhir.

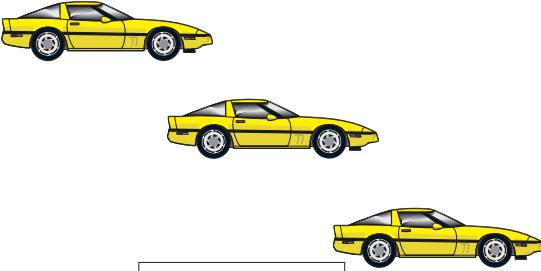

Three yellow cars are arranged in a descending staircase pattern from top-left to bottom-right. Below them is a large empty square box for writing, and a blue pencil is positioned at the bottom right corner of the box.

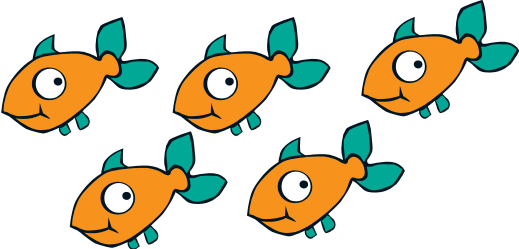

Five orange fish with green fins are arranged in a descending staircase pattern from top-left to bottom-right. Below them is a large empty square box for writing, and a blue pencil is positioned at the bottom right corner of the box.

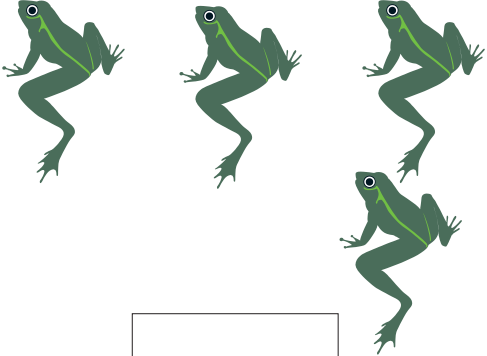

Four green frogs are arranged in a descending staircase pattern from top-left to bottom-right. Below them is a large empty square box for writing, and a blue pencil is positioned at the bottom right corner of the box.

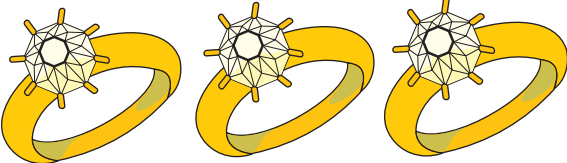

Three gold rings with white gemstones are arranged in a descending staircase pattern from top-left to bottom-right. Below them is a large empty square box for writing, and a blue pencil is positioned at the bottom right corner of the box.

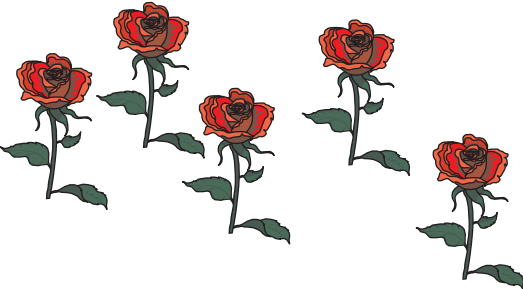

Five red roses on green stems are arranged in a descending staircase pattern from top-left to bottom-right. Below them is a large empty square box for writing, and a blue pencil is positioned at the bottom right corner of the box.

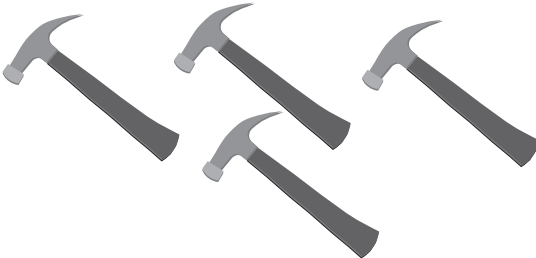

Four hammers are arranged in a descending staircase pattern from top-left to bottom-right. Below them is a large empty square box for writing, and a blue pencil is positioned at the bottom right corner of the box.

Scríobh síos an uimhir.

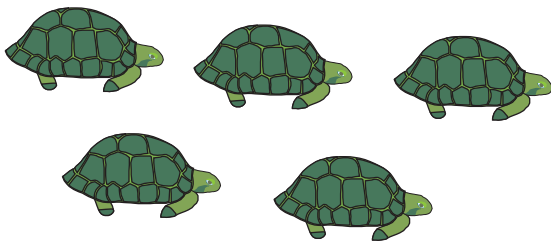
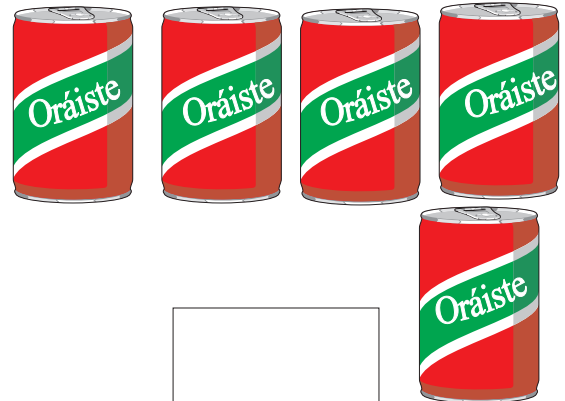
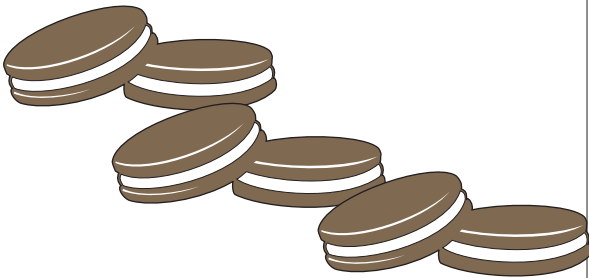
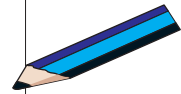
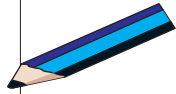
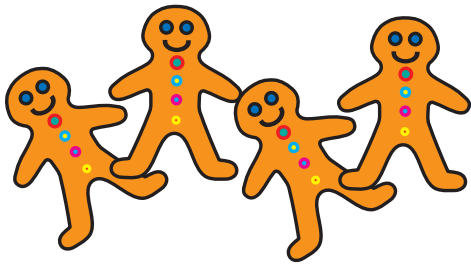

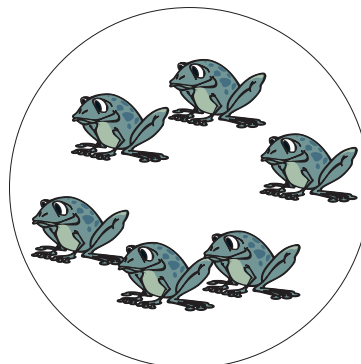
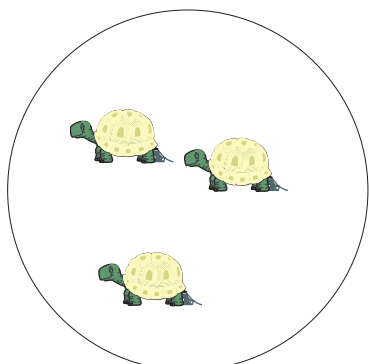
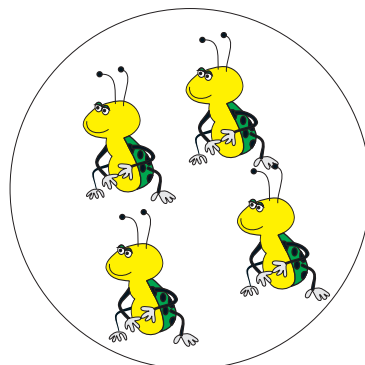
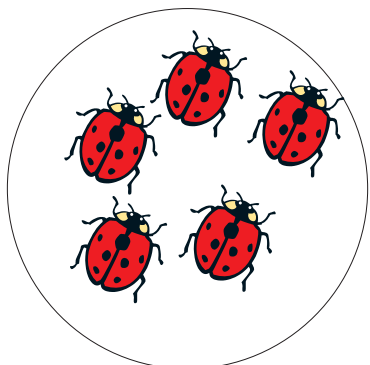
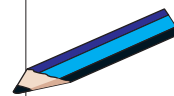
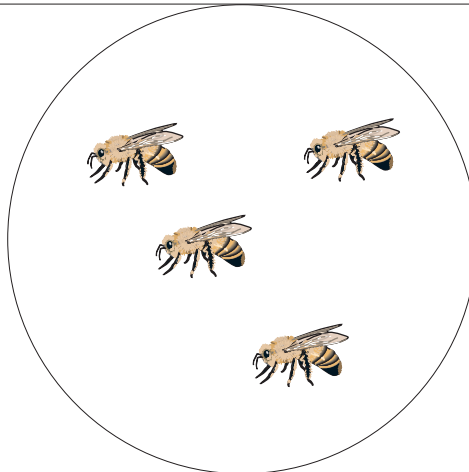
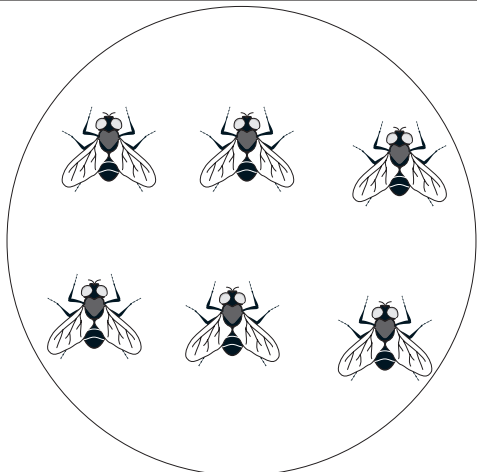

Tarraing an líon ceart ciorcal i ngach bosca.

3

6

2

1

4

5

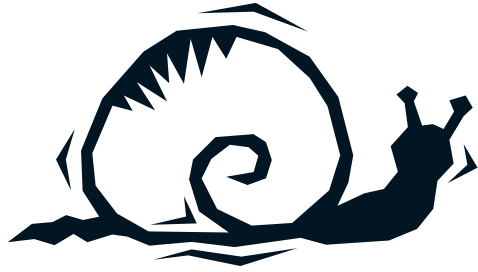

Dhá sheilide (2)



Tarraing seilide amháin (1) eile.

3

Tarraing ceann amháin (1) eile.

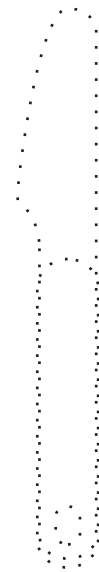
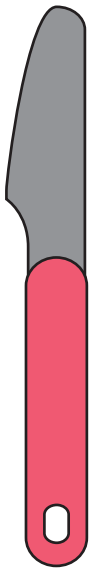
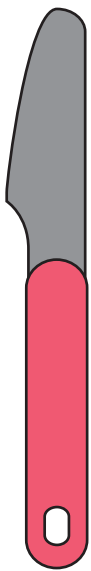

Cé mhéad scian?



Tarraing ceann amháin (1) eile.

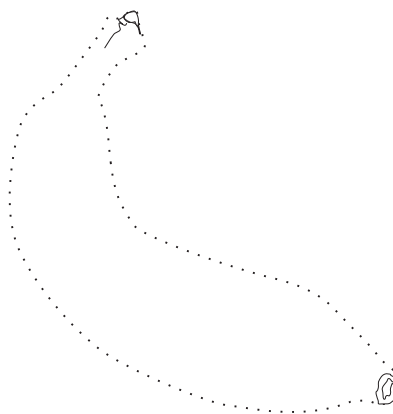
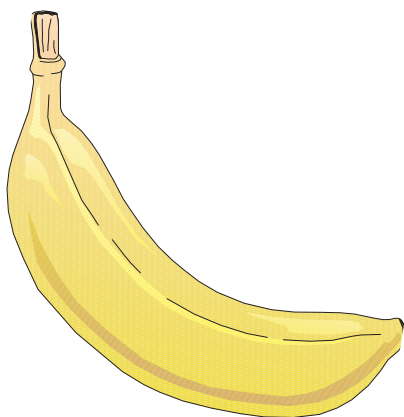
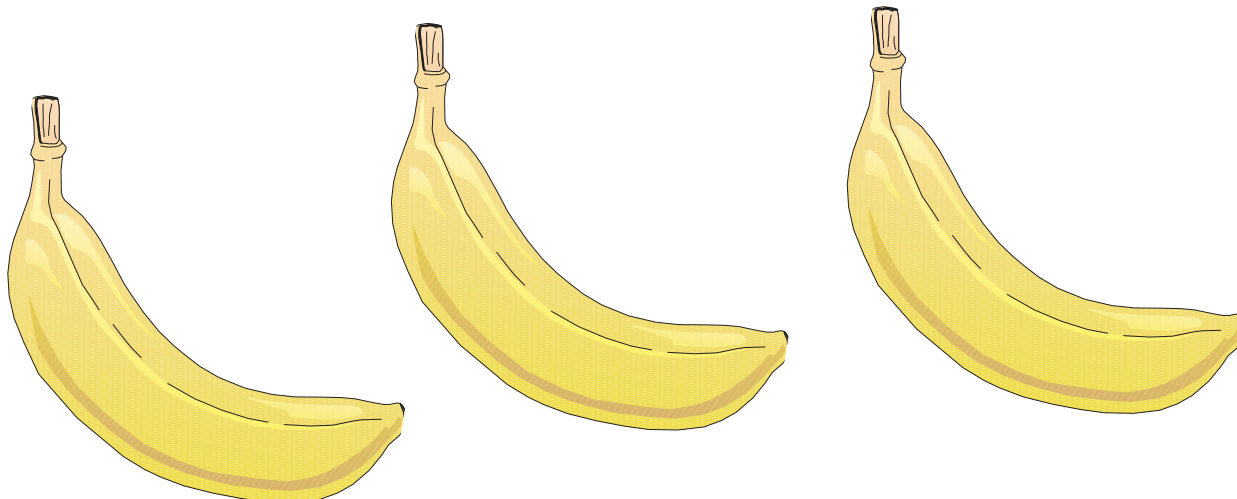

Cé mhéad banana?



Tarraing ceann amháin (1) eile.

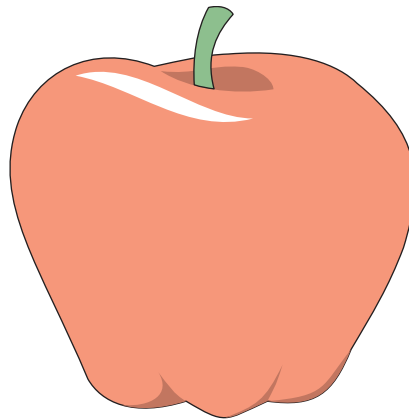
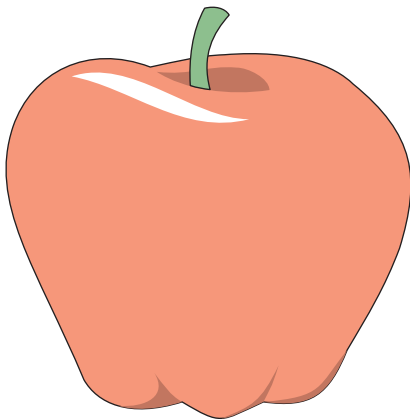
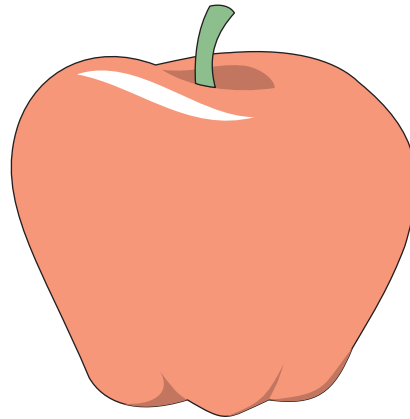
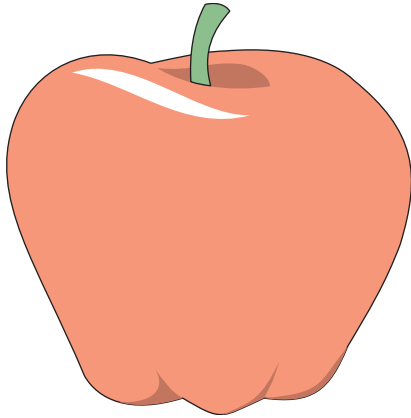

Cé mhéad úll?

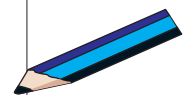

Tarraing dhá ceann (2) eile.

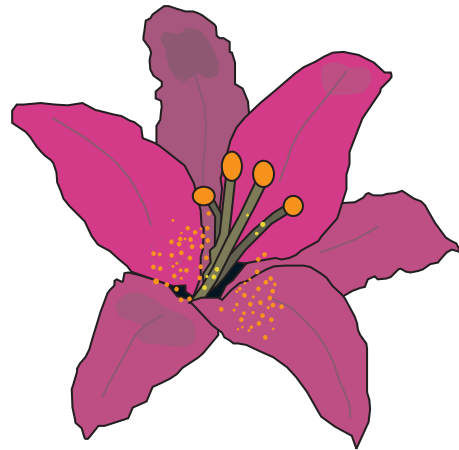

Cé mhéad bláth?



Tarraing trí cinn (3) eile.



Cé mhéad fear sneachta?

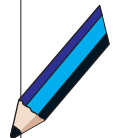

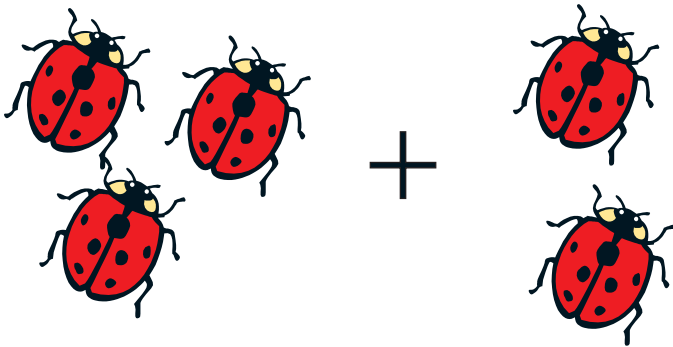

$$3 + 2 = 5$$

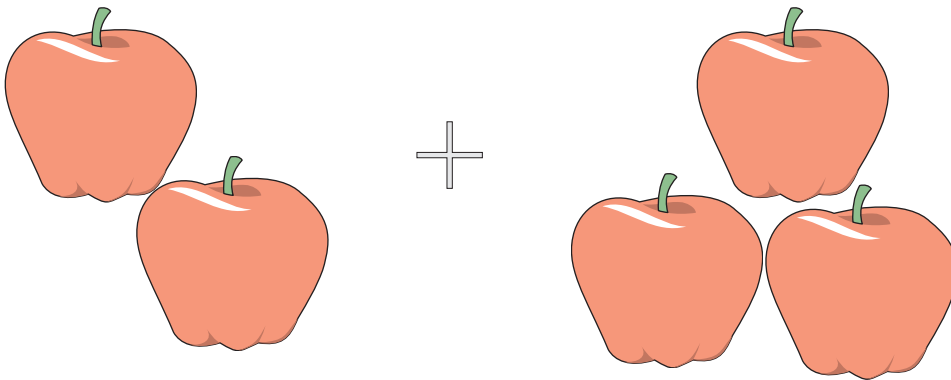

$$2 + 3 = \square$$

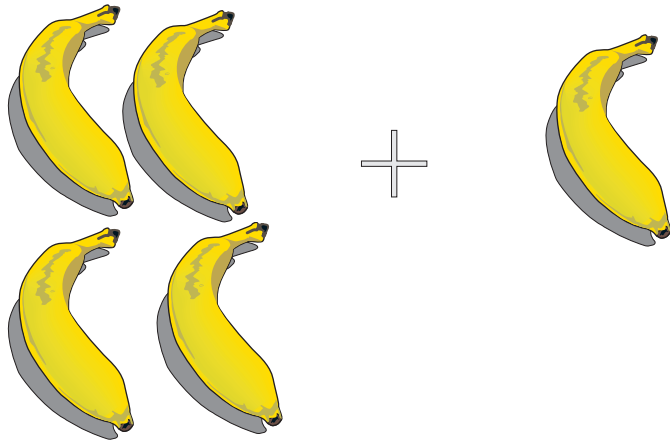

$$4 + 1 = \square$$

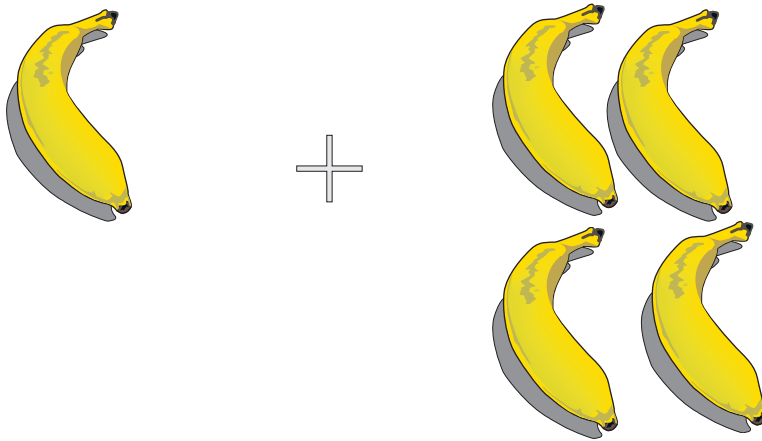

$$1 + 4 = \square$$

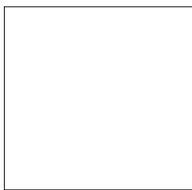
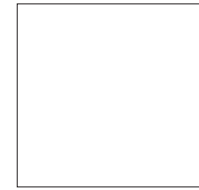
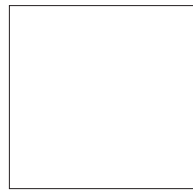
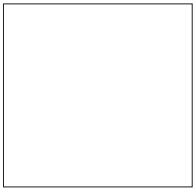
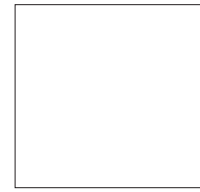
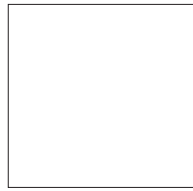
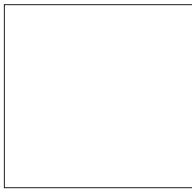

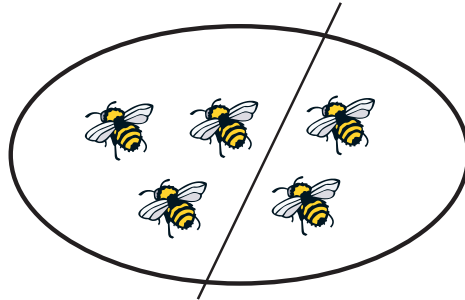

$$5 = 3 + 2$$

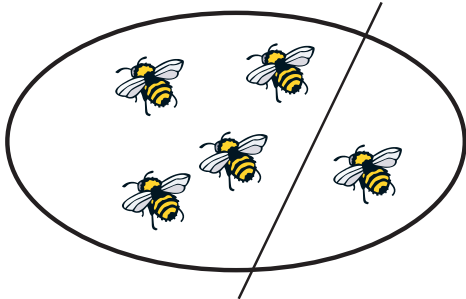

$$\square = \square + \square$$

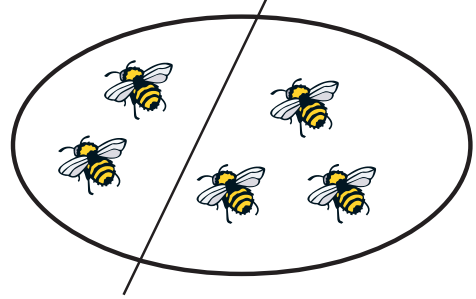

$$\square = \square + \square$$

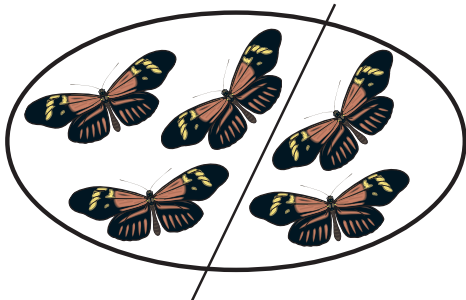

$$\square = \square + \square$$

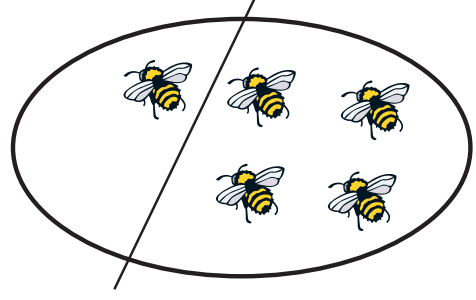

$$\square = \square + \square$$

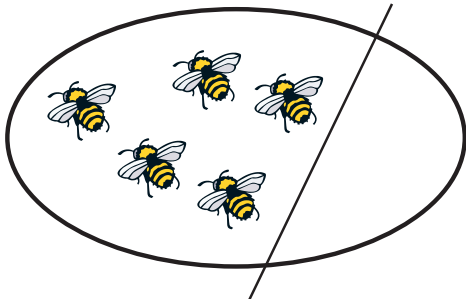

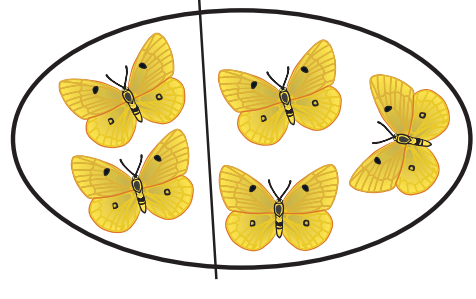

$$\square = \square + \square$$



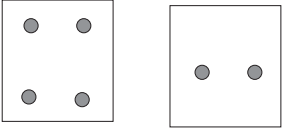
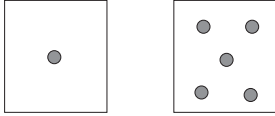

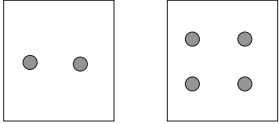
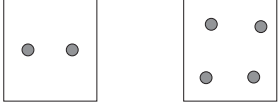
$$\square = \square + \square$$

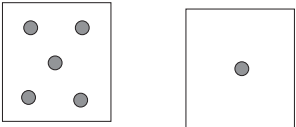
	
$4 + 2 = \square$	$1 + 5 = \square$

	
$2 + 4 = \square$	$2 + \square = \square$

	
$5 + \square = \square$	$3 + \square = \square$

	
$\square + \square = \square$	$\square + \square = \square$

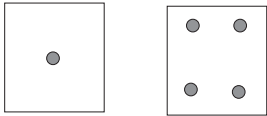
	
$\square + \square = \square$	$\square + \square = \square$

Dathaigh mé!

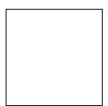
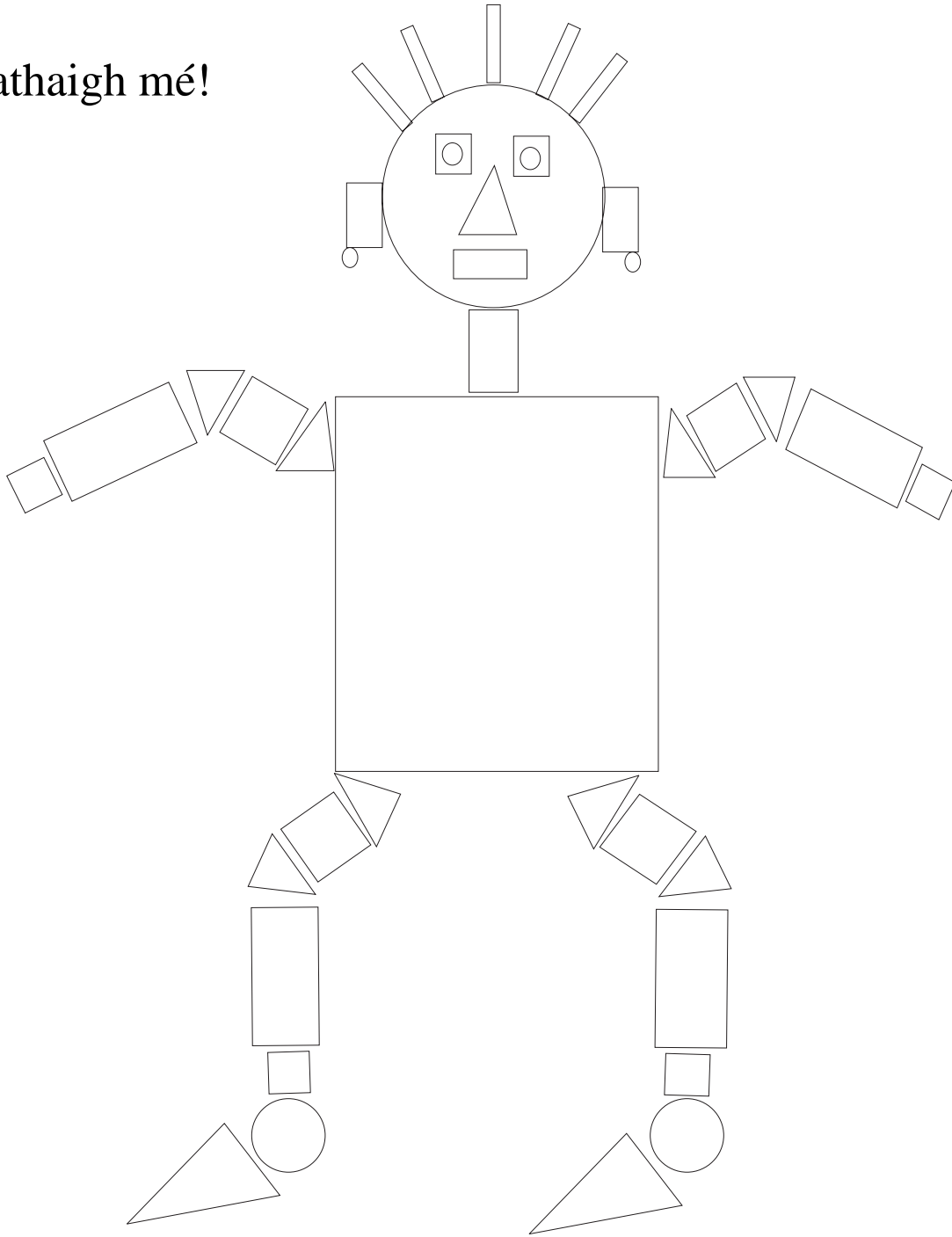

glas



dearg

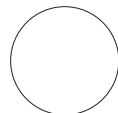

gorm





buí

	
<input style="width: 40px; height: 30px; border: 1px solid black;" type="text"/> + <input style="width: 40px; height: 30px; border: 1px solid black;" type="text"/> = <input style="width: 40px; height: 30px; border: 1px solid black;" type="text"/>	<input style="width: 40px; height: 30px; border: 1px solid black;" type="text"/> + <input style="width: 40px; height: 30px; border: 1px solid black;" type="text"/> = <input style="width: 40px; height: 30px; border: 1px solid black;" type="text"/>

	
<input style="width: 40px; height: 30px; border: 1px solid black;" type="text"/> + <input style="width: 40px; height: 30px; border: 1px solid black;" type="text"/> = <input style="width: 40px; height: 30px; border: 1px solid black;" type="text"/>	<input style="width: 40px; height: 30px; border: 1px solid black;" type="text"/> + <input style="width: 40px; height: 30px; border: 1px solid black;" type="text"/> = <input style="width: 40px; height: 30px; border: 1px solid black;" type="text"/>

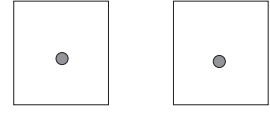
	
<input style="width: 40px; height: 30px; border: 1px solid black;" type="text"/> + <input style="width: 40px; height: 30px; border: 1px solid black;" type="text"/> = <input style="width: 40px; height: 30px; border: 1px solid black;" type="text"/>	<input style="width: 40px; height: 30px; border: 1px solid black;" type="text"/> + <input style="width: 40px; height: 30px; border: 1px solid black;" type="text"/> = <input style="width: 40px; height: 30px; border: 1px solid black;" type="text"/>

	
<input style="width: 40px; height: 30px; border: 1px solid black;" type="text"/> + <input style="width: 40px; height: 30px; border: 1px solid black;" type="text"/> = <input style="width: 40px; height: 30px; border: 1px solid black;" type="text"/>	<input style="width: 40px; height: 30px; border: 1px solid black;" type="text"/> + <input style="width: 40px; height: 30px; border: 1px solid black;" type="text"/> = <input style="width: 40px; height: 30px; border: 1px solid black;" type="text"/>

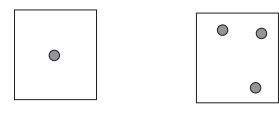
	
<input style="width: 40px; height: 30px; border: 1px solid black;" type="text"/> + <input style="width: 40px; height: 30px; border: 1px solid black;" type="text"/> = <input style="width: 40px; height: 30px; border: 1px solid black;" type="text"/>	<input style="width: 40px; height: 30px; border: 1px solid black;" type="text"/> + <input style="width: 40px; height: 30px; border: 1px solid black;" type="text"/> = <input style="width: 40px; height: 30px; border: 1px solid black;" type="text"/>

6

a seacht

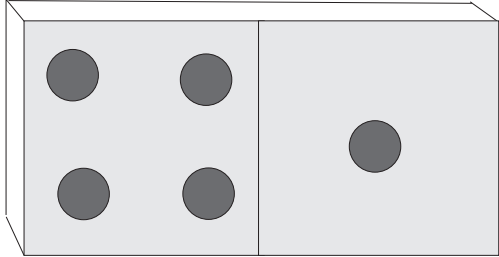

4

a cúig

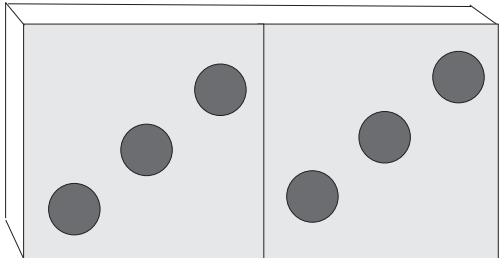

7

a sé

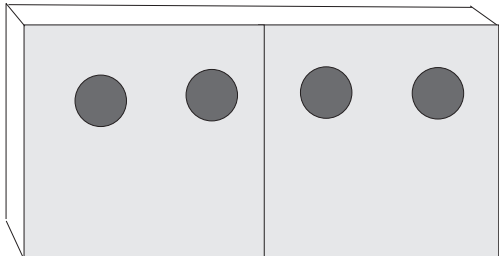

5

a ceathair

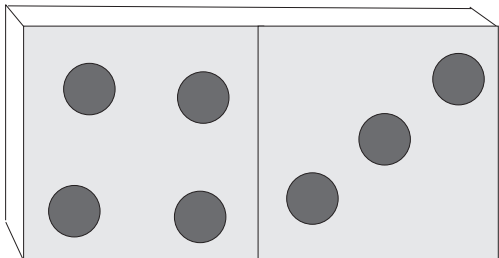

3 bhorróg

Tarraing ceann
amháin (1) eile.Cé mhéad
bhorróg anois?

5 úll

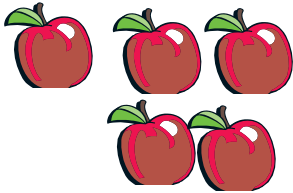
Tarraing ceann
amháin (1) eile.Cé mhéad
úll anois?

6 reoiteog

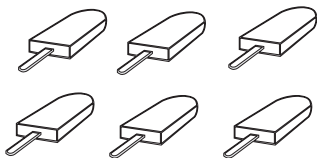
Tarraing ceann
amháin (1) eile.Cé mhéad
reoiteog anois?

4 shicín

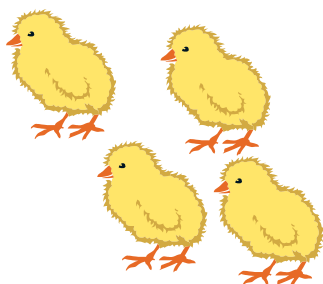
Tarraing ceann
amháin (1) eile.Cé mhéad
sicín anois?

3 chupán



Tarraing ceann
amháin (1) eile.

Cé mhéad
cupán anois?

5 bhuidéal



Tarraing ceann
amháin (1) eile.

Cé mhéad
buidéal anois?

6 bhloc

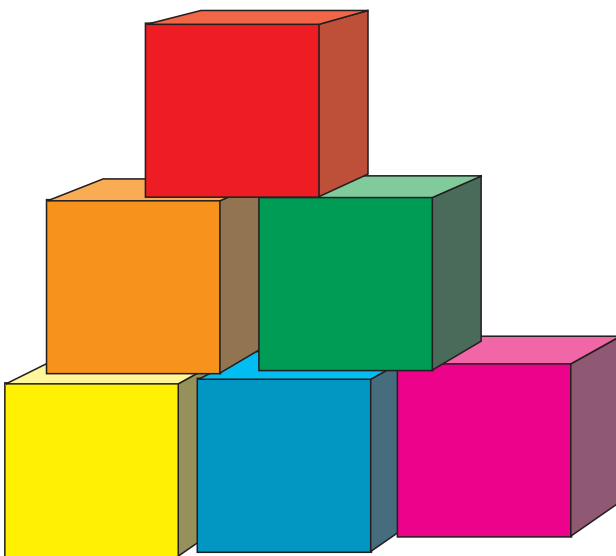

Tarraing ceann
amháin (1) eile.

Cé mhéad
bloc anois?

1 iasc amháin

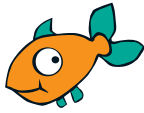
Tarraing péire (2)
eile.Cé mhéad
iasc anois?

2 chearnóg

Tarraing péire (2)
eile.Cé mhéad
cearnóg
anois?

2 chiorcal

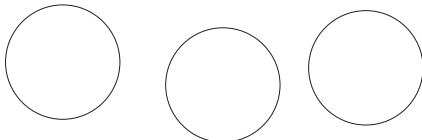
Tarraing trí cinn (3)
eile.Cé mhéad
ciorcal
anois?

2 pheann luaidhe

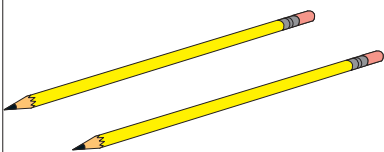
Tarraing ceithre
cinn (4) eile.Cé mhéad
peann
luaidhe
anois?

a Seacht

7

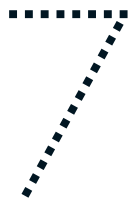
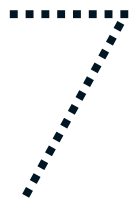
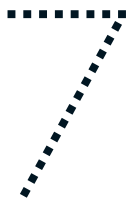
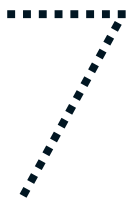
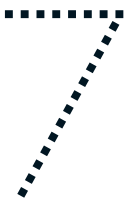
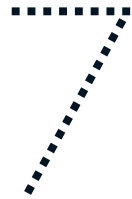
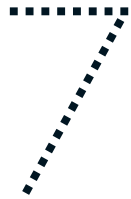
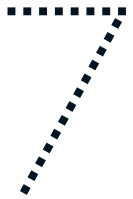
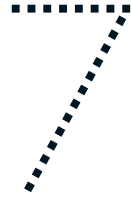
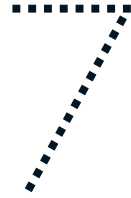
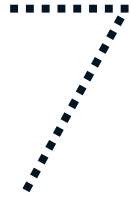
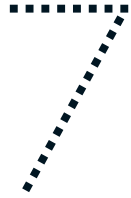
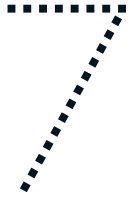
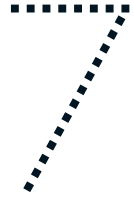
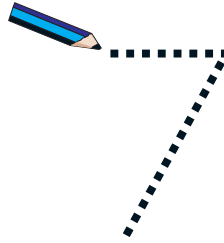

Seacht gcinn

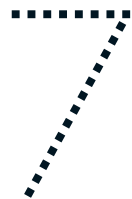
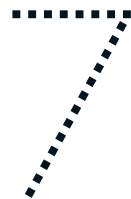
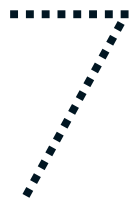
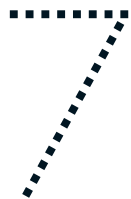
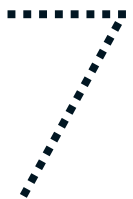

Ceangail an 7 de na tacair ina bhfuil 7 rud.

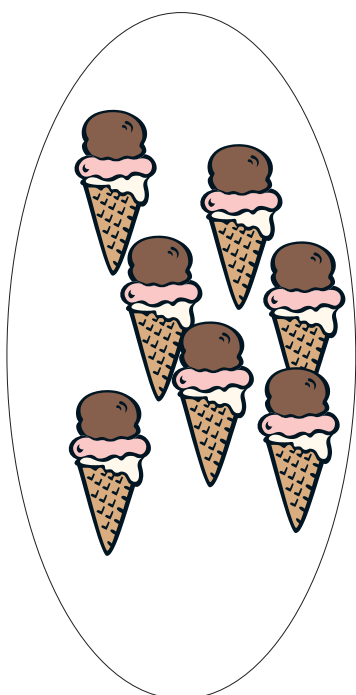
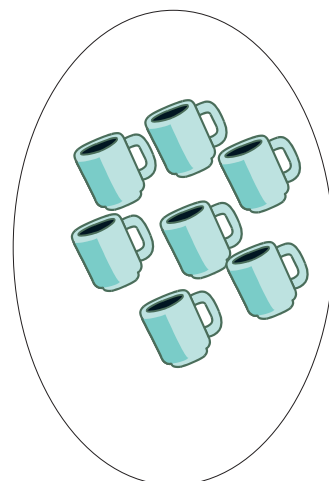
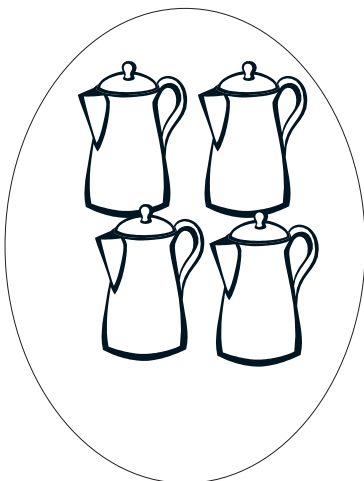
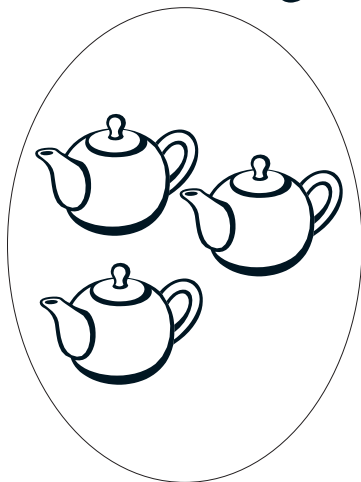

7

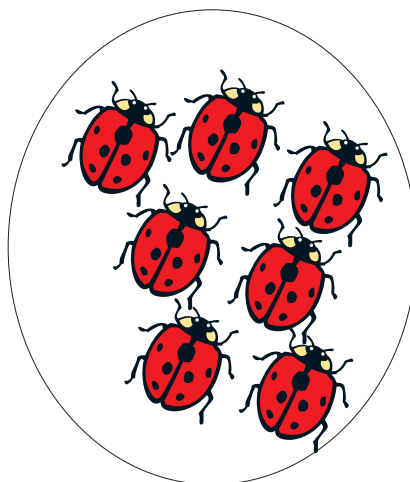
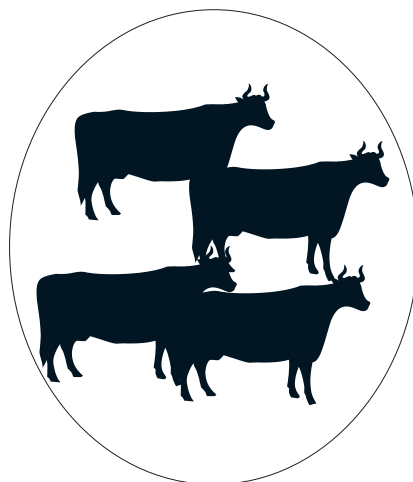

Cuir líne timpeall ar na tacair ina bhfuil 7 rud.

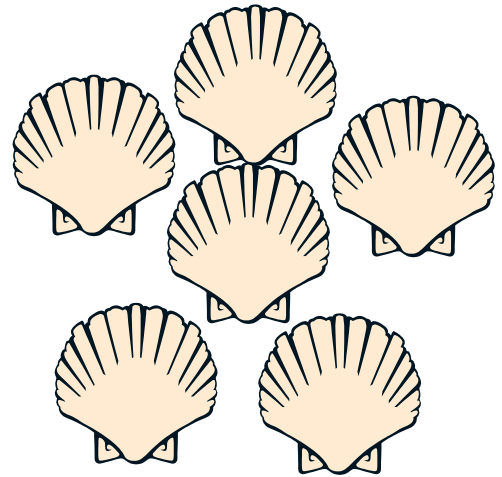
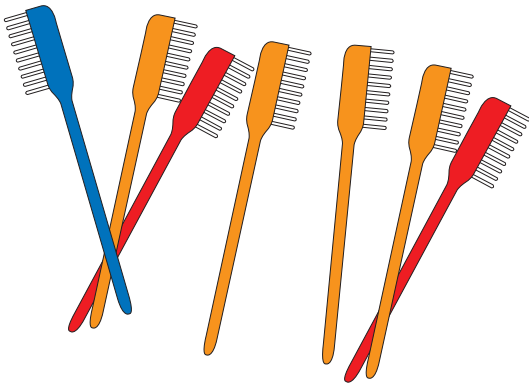
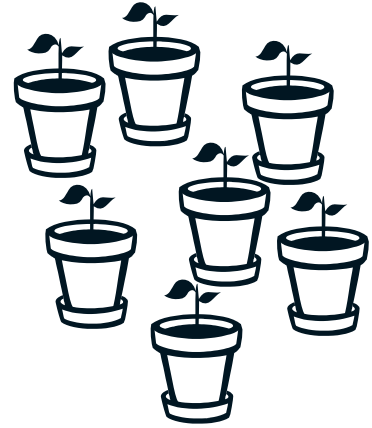

Ith ceann amháin (1).

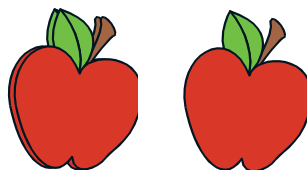

Cé mhéad úll fágtha?

Ith ceann amháin (1).

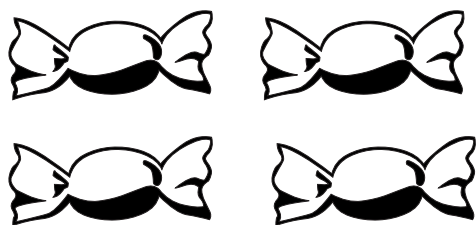

Cé mhéad milseán fágtha?

Ith ceann amháin (1).



Cé mhéad líreacán fágtha?

Ith ceann amháin (1).



Cé mhéad uachtar reoite fágtha?

A haon, a dó

A haon, a dó,

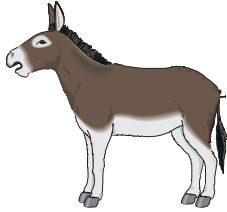

Asal agus bó.

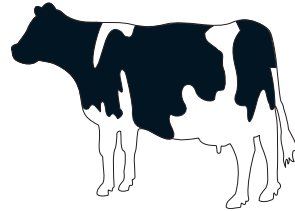

A trí, a ceathair,

Bróga leathair.

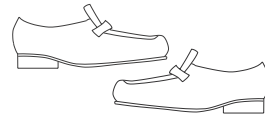

A cúig, a sé,

Cupán tae.



A seacht, a hocht,

Seanbhean bhocht.



A naoi, a deich,

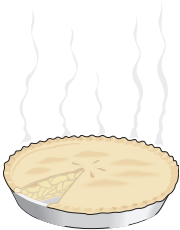

Císte te.

Fada agus Gearr



an ceann is giorra



an ceann is faide

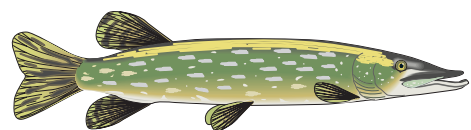
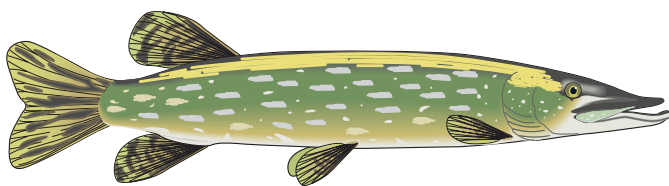
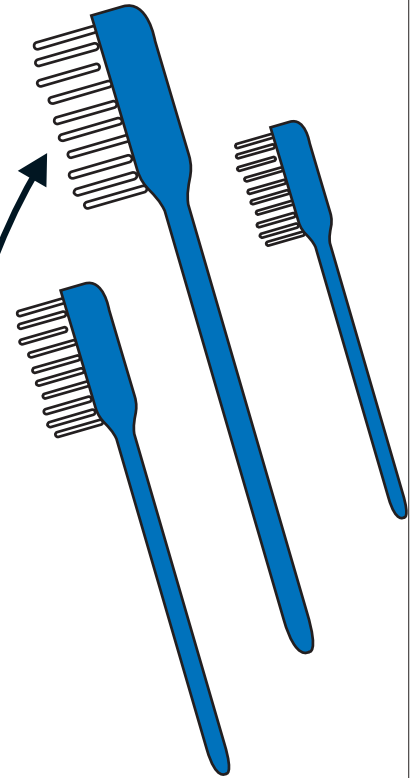

Scríobh síos an figiúr.

a haon
a haon



a dó
a dó



a trí
a trí



a ceathair
a ceathair



a cúig
a cúig



a sé
a sé



a seacht
a seacht



Scéal a Dó

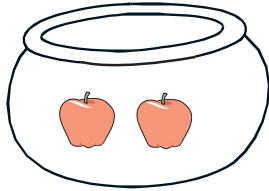

2

+



0

=

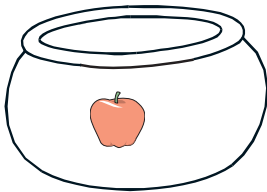

1

+

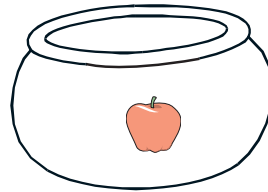

1

=



0

+

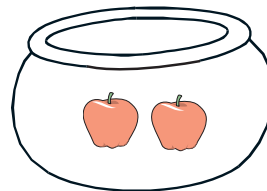

2

=

Aon, dó, aon, dó, trí,

1 ●

2 ● ●

3 ● ●

Luichíní istigh sa tuí.



Ceathair, cúig, ceathair, cúig, sé,

4 ● ●

5 ● ● ●

6 ● ● ● ●

Tháinig gandal is cúpla gé.

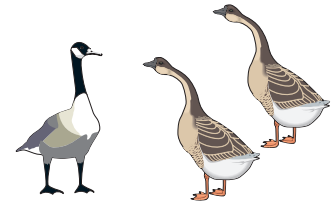

Seacht, ocht, seacht, ocht, naoi,

7 ● ● ● ● ●

8 ● ● ● ● ● ●

9 ● ● ● ● ● ● ●

Thosaigh siad ag déanamh spraoi.



Scéal a Trí

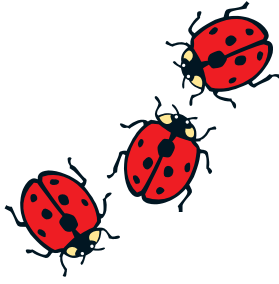

3

+

0

=

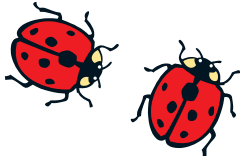

2

+



1

=



1

+

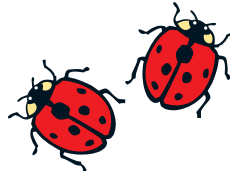

2

=

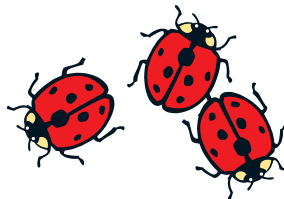

0

+

3

=

Suimigh 1 leo.



Faigh an freagra ceart.
Ceangail na huimhreacha.

2
|
3

3
4
2

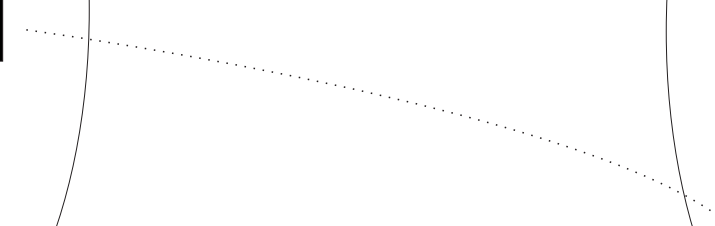

Ith ceann amháin (1).



Faigh an freagra ceart.
Ceangail na huimhreacha.

5
3
2

2
|
4

Suimigh 1 leo.



3
1
2

Faigh an freagra ceart.
Ceangail na huimhreacha.

0
1
2

Ith ceann amháin (1).



4
1
3

Faigh an freagra ceart.
Ceangail na huimhreacha.

0
3
2

Meaitseáil na cruthanna.

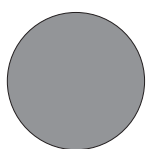
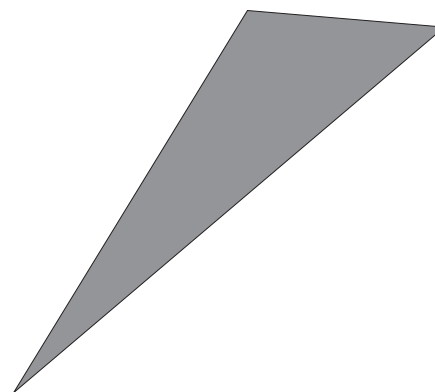
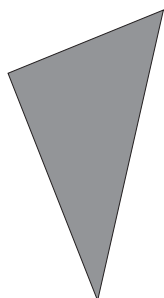
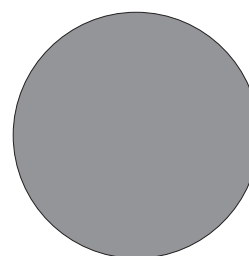
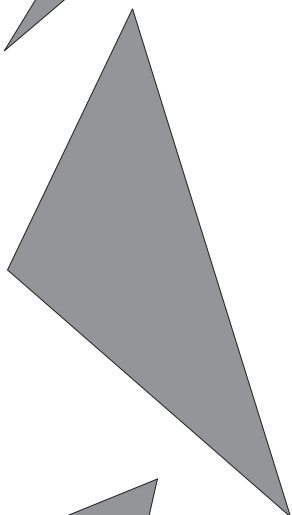
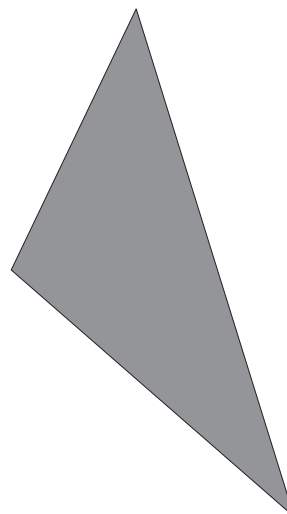
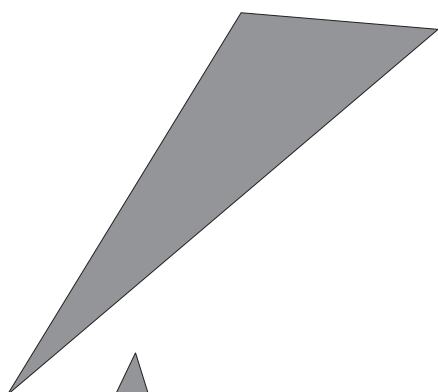
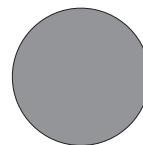
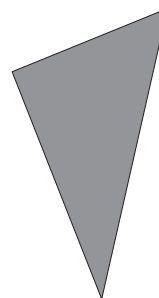
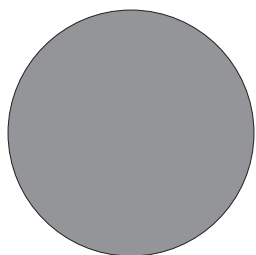

Ceangail an focal ceart den chruth.

cearnóg

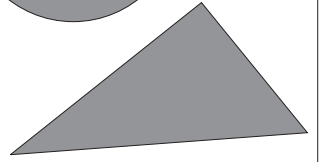
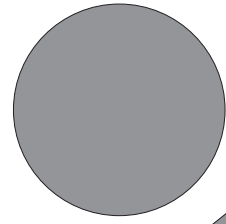

triantán

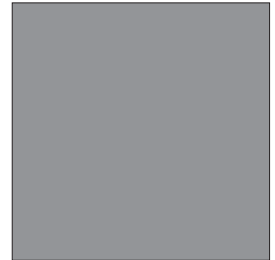

dronuilleog

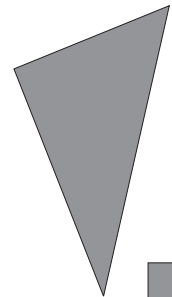

ciorcal

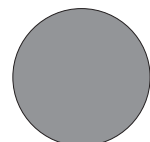

Cuir líne timpeall ar na focail atá ar eolas agat.

cé mhéad?

a dó

cearnóg

ith

a sé

suimigh

dathaigh

a trí

triantán

a haon

a cúig

ciorcal

a ceathair

a seacht

Ceangail na poncanna agus dathaigh an pictiúr.

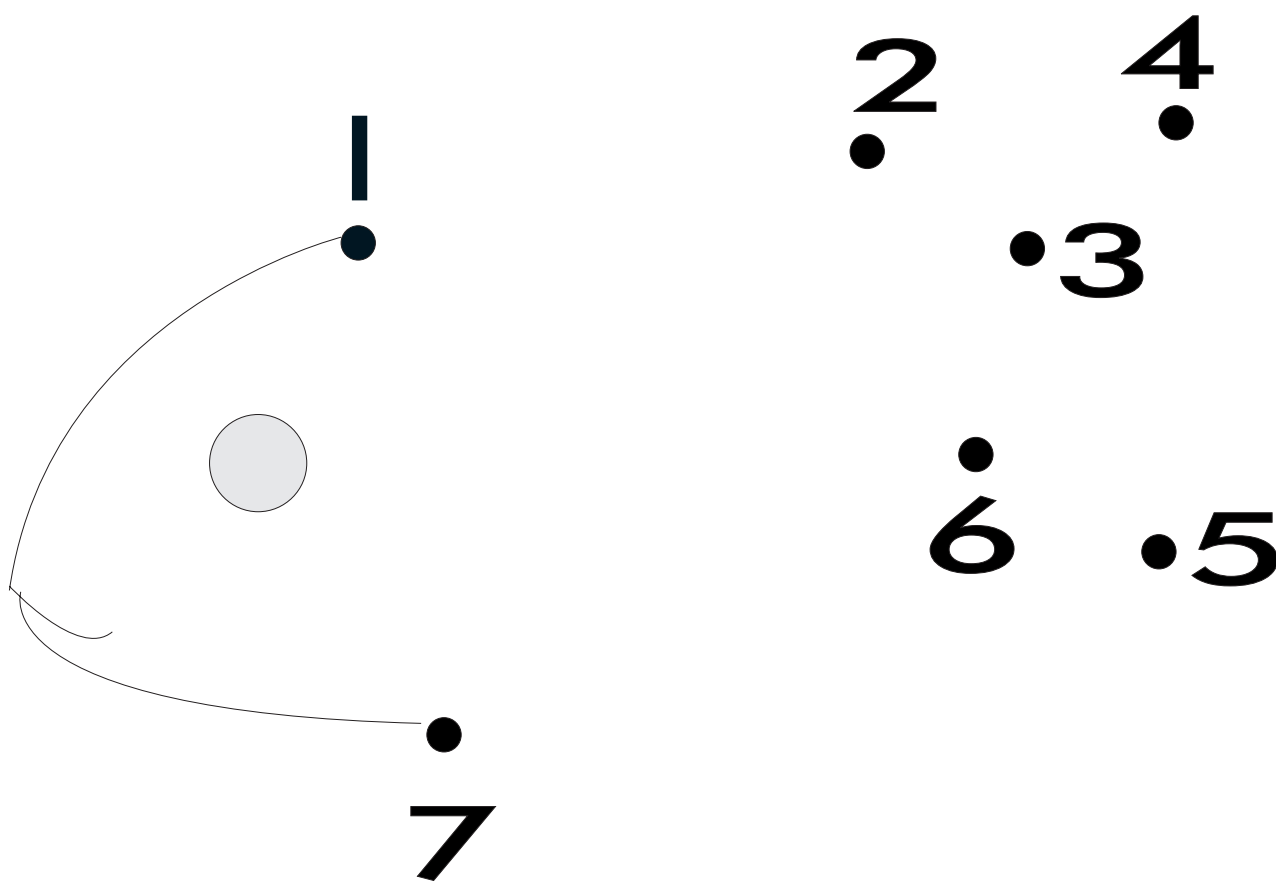

Ceangail na poncanna agus dathaigh an pictiúr.

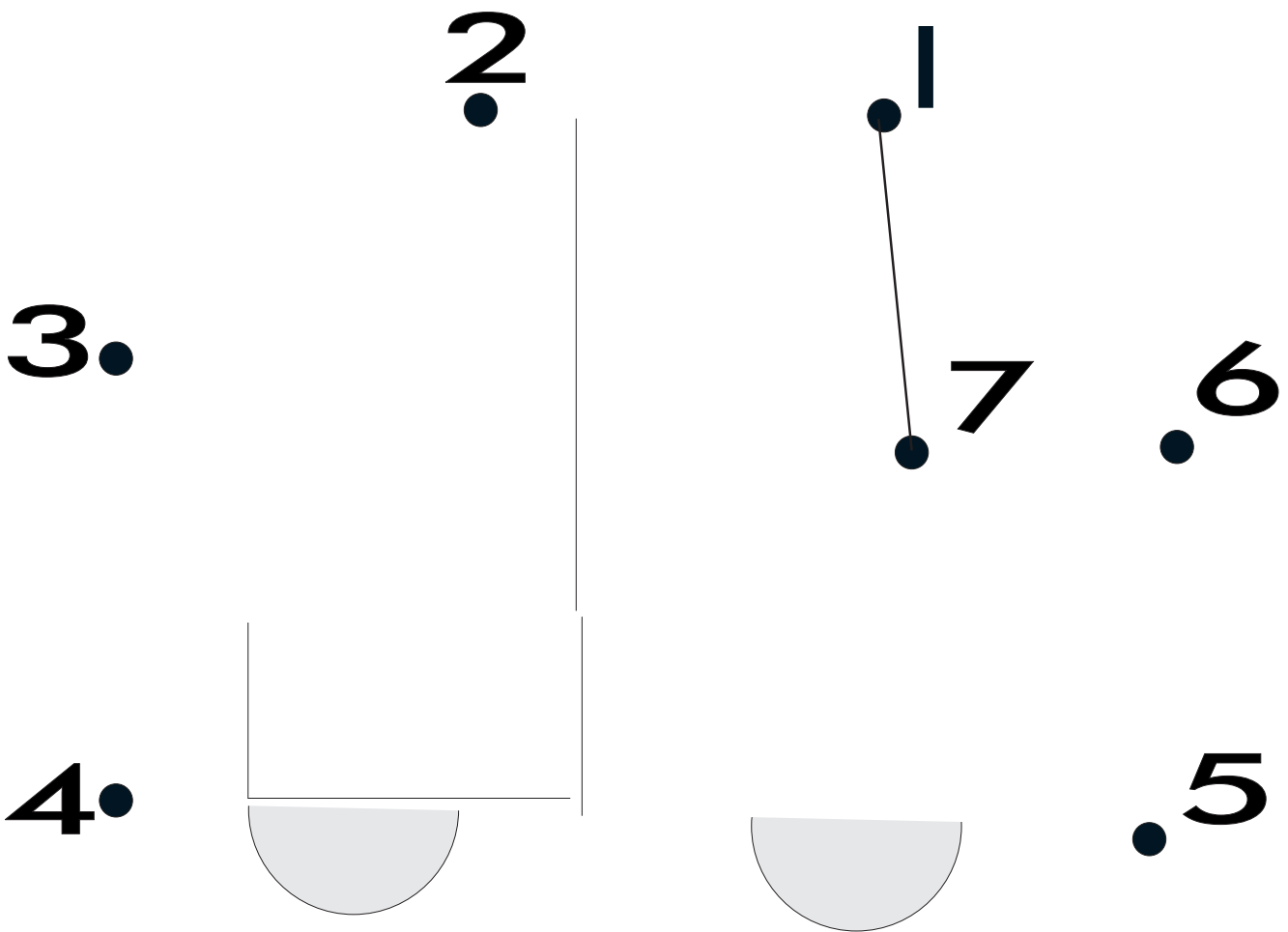

Ceangail na poncanna agus dathaigh an pictiúr.

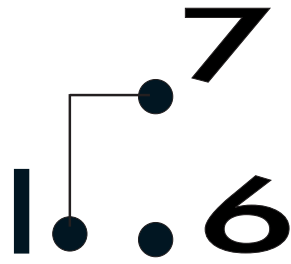

2

5

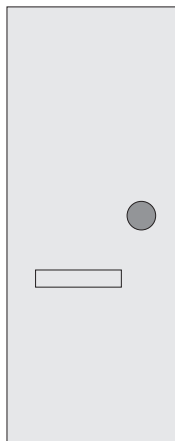

3

4

Ceangail na poncanna agus dathaigh an pictiúr.

4. 2

5 .3 ! 6
7

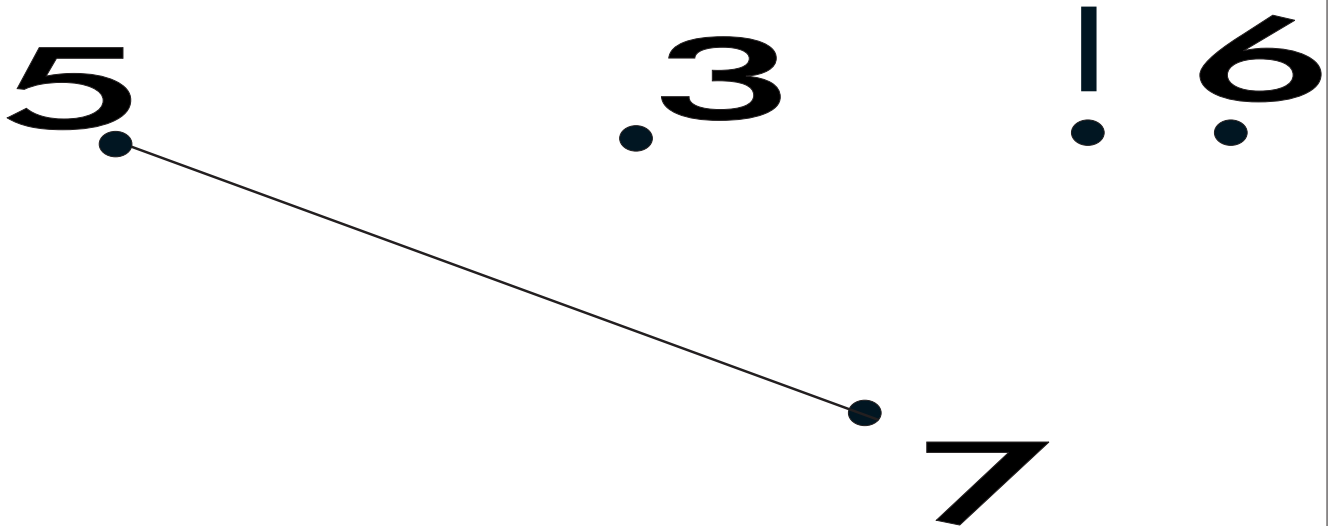

Ceangail na poncanna agus dathaigh na cruthanna.

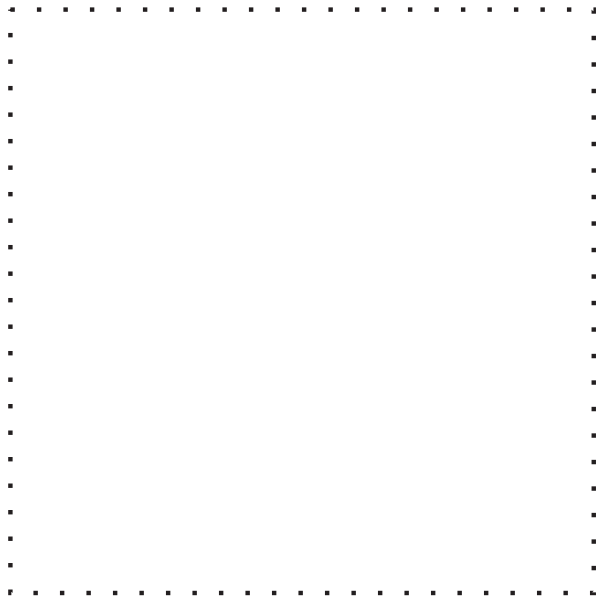

cearnóg

cearnóg

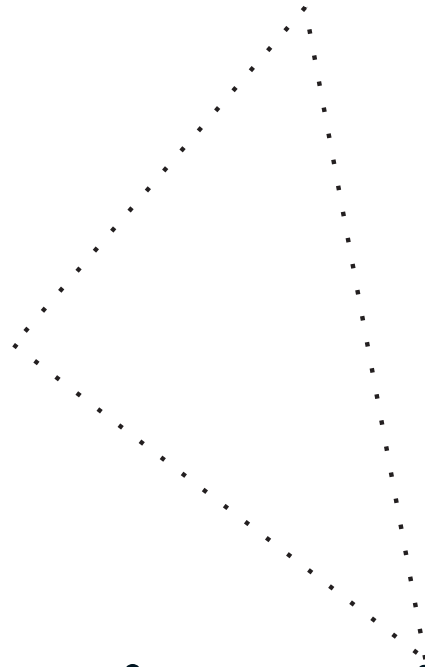

triantán

triantán



dronuilleog

dronuilleog

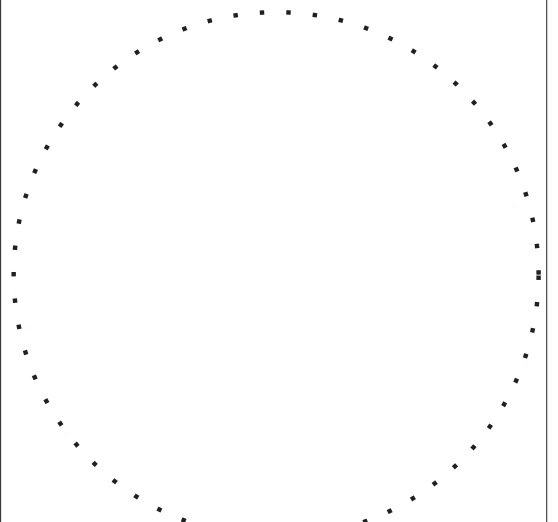

ciorcal

ciorcal

Tá níos mó ag ...

Pól

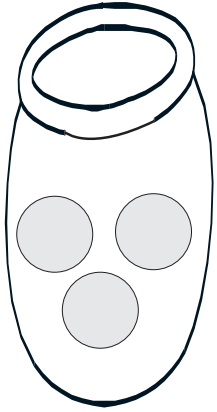

Síle

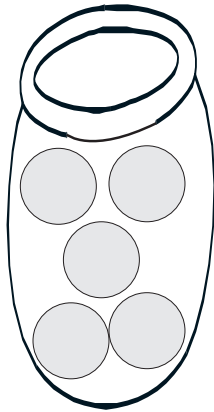

Seán

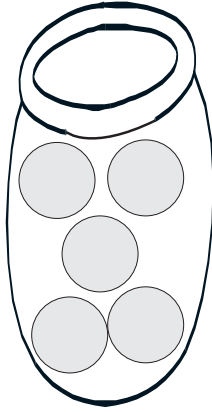

Máire

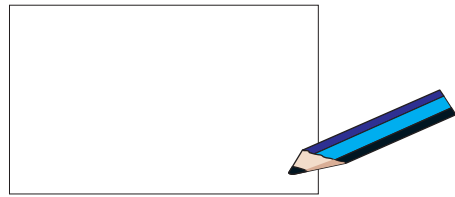
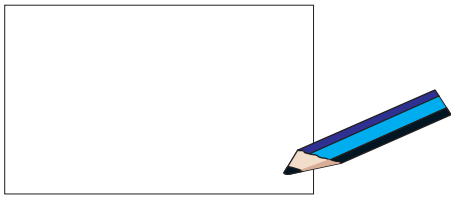
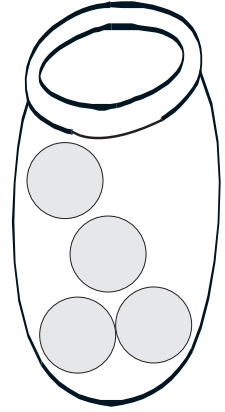

Liam

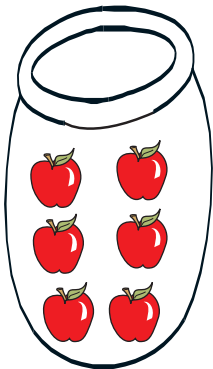

Bríd

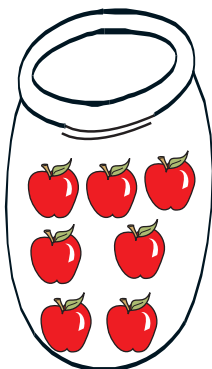

Marcas

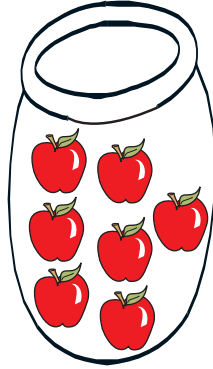

Tomás

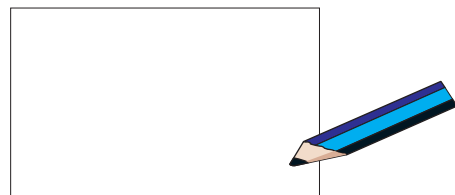
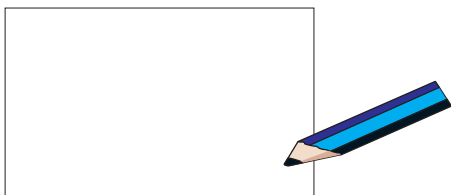
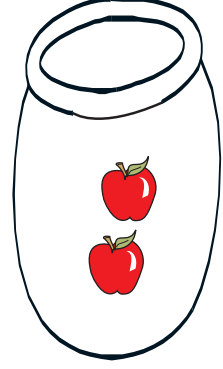

A

B

C

An ceann is faide =

An ceann is giorra =

siopa

A

B

C

D



An ceann is faide =

An ceann is giorra =

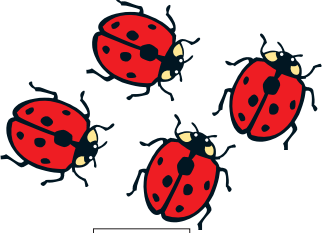
Scéal a Ceathair



4 + **0** =

3 + **1** =

2 + **2** =

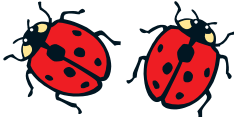

1 + **3** =



0 + **4** =

Suimigh 1 leo.



Faigh an freagra ceart.
Ceangail na huimhreacha.

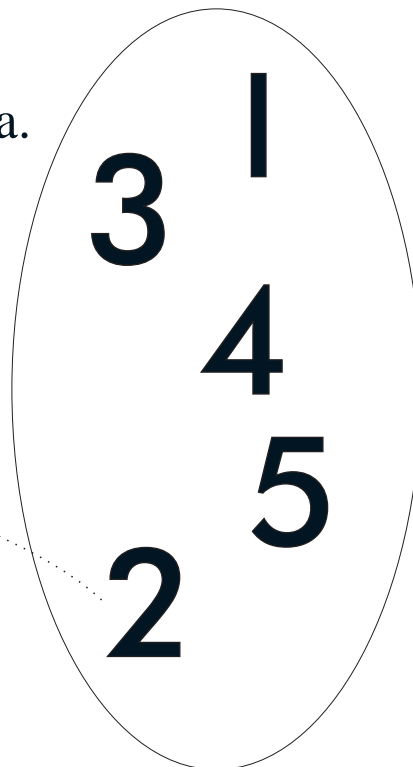
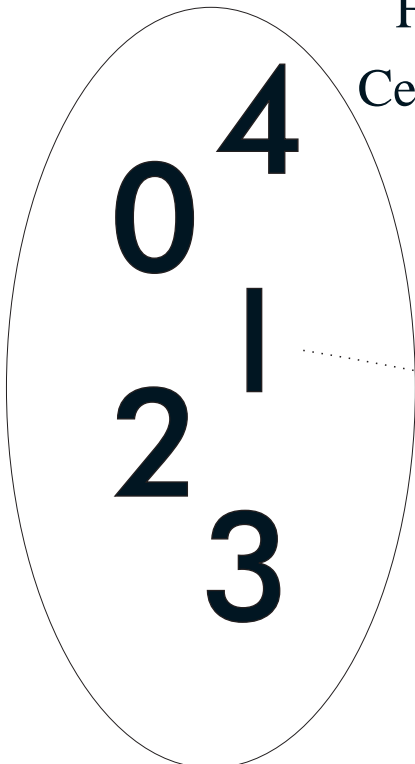

Suimigh 1 leo.



Faigh an freagra ceart.
Ceangail na huimhreacha.

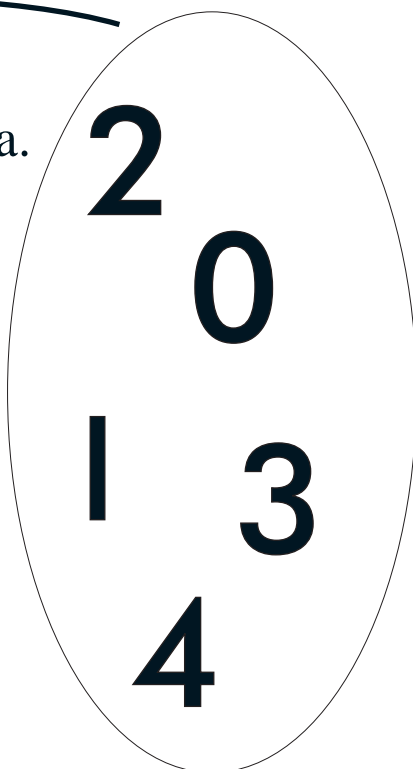
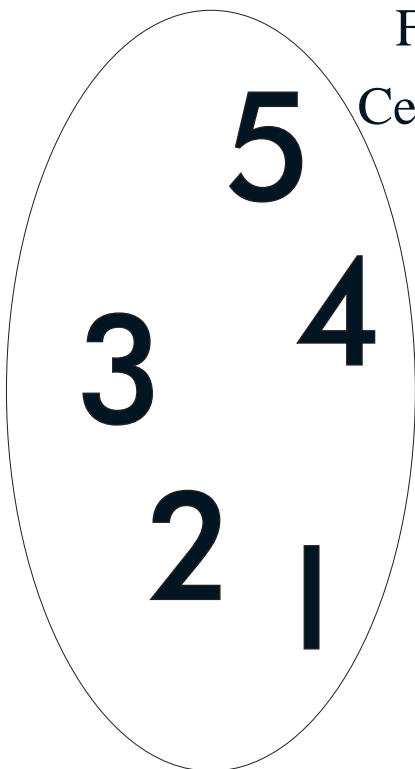

a hOcht 8

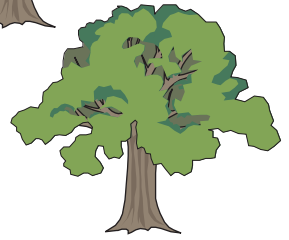
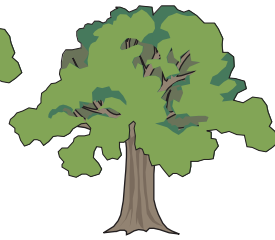
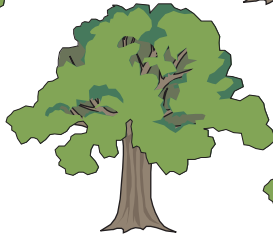
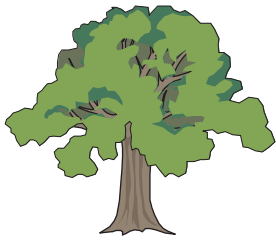
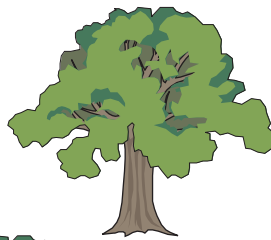
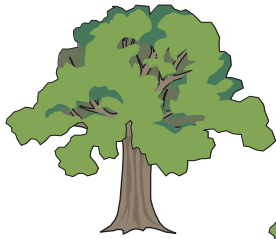
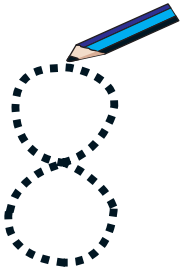
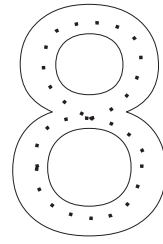

Ocht gcinn



Cé mhéad rud i ngach tacar?

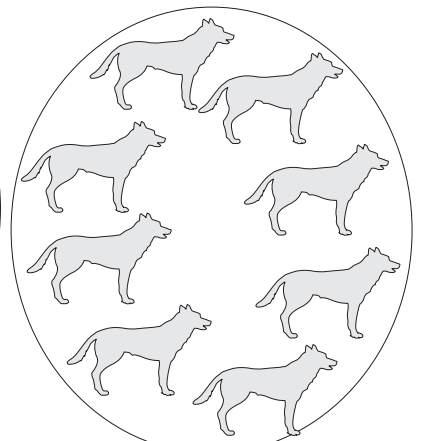
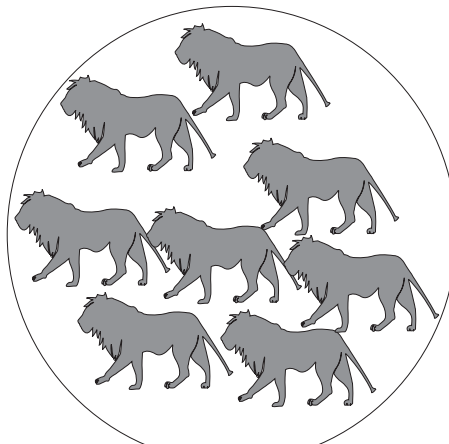
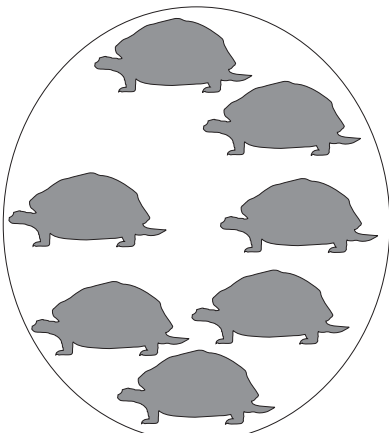
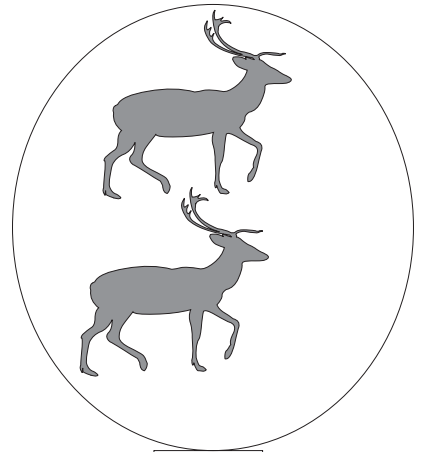
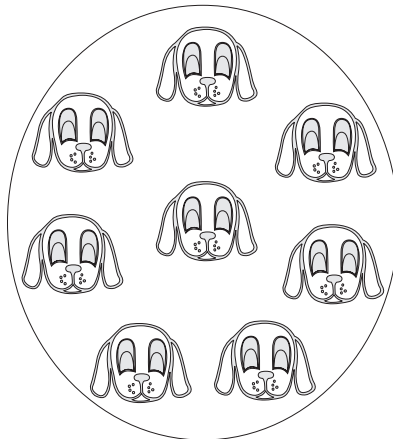
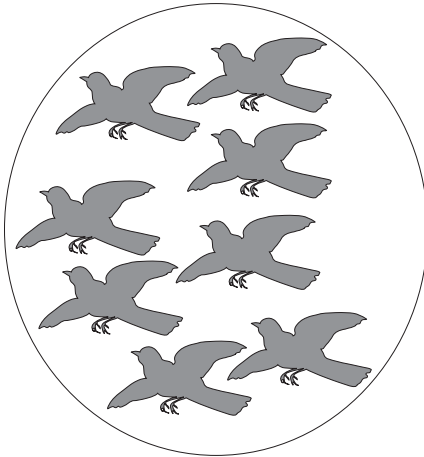
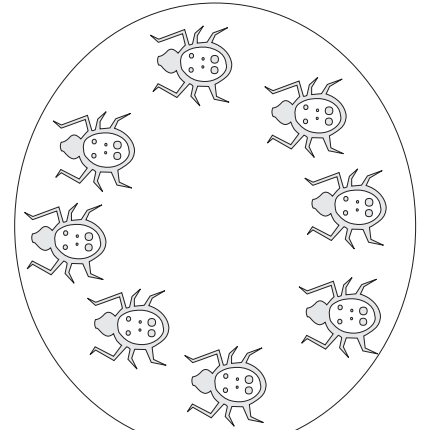
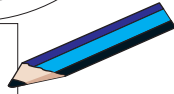
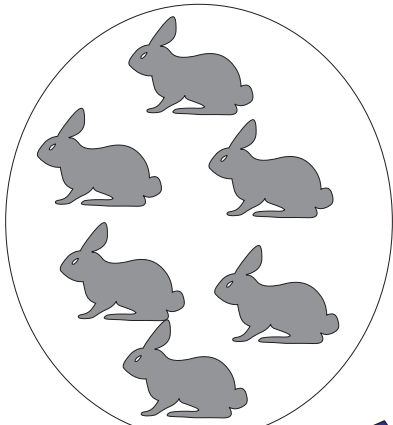

Ceangail na poncanna agus dathaigh an cruth.

1.

8

7

2.

.6

3.

4

.5

Ceangail na poncanna agus dathaigh an cruth.

1.

2.

.8

3.

.7

4.

5

.6

Cé mhéad rud i ngach tacar?

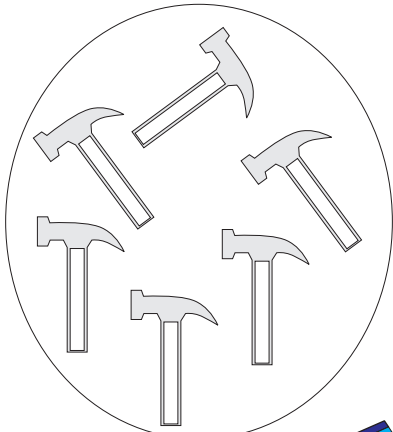

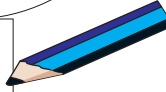
□ 

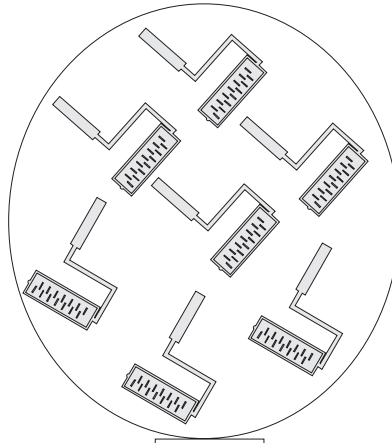

□

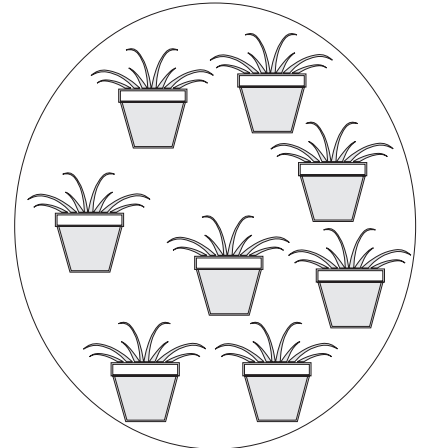

□

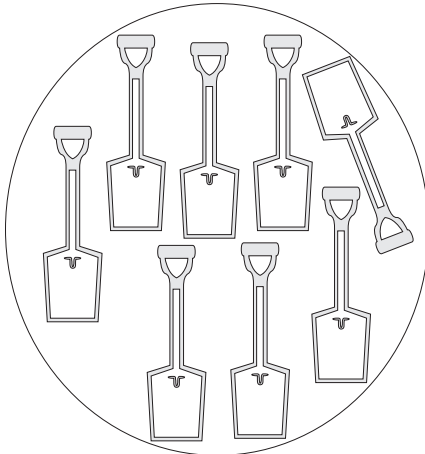

□

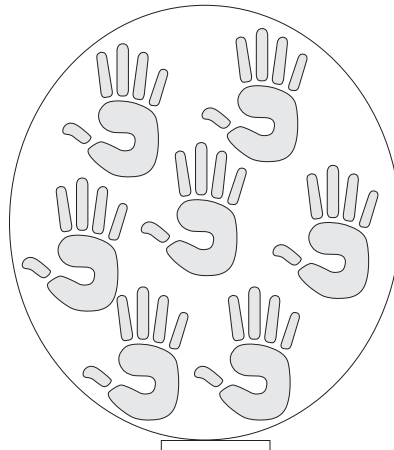

□

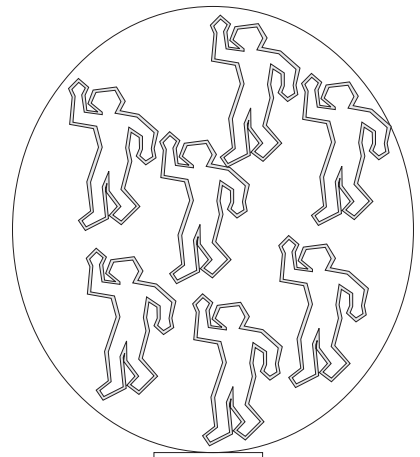

□

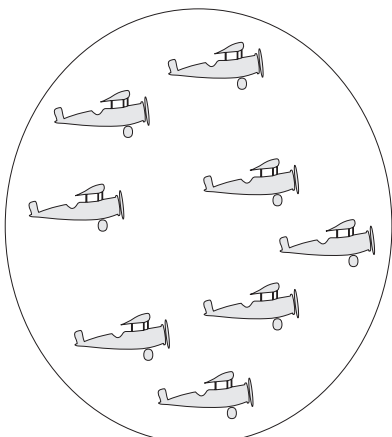

□

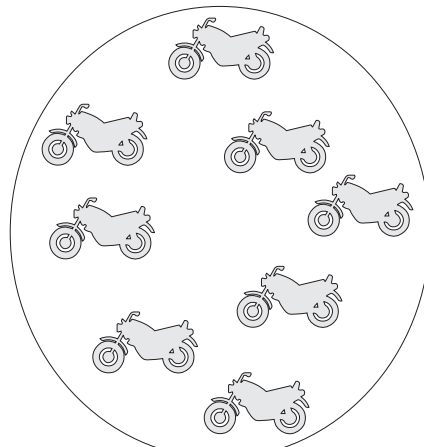

□

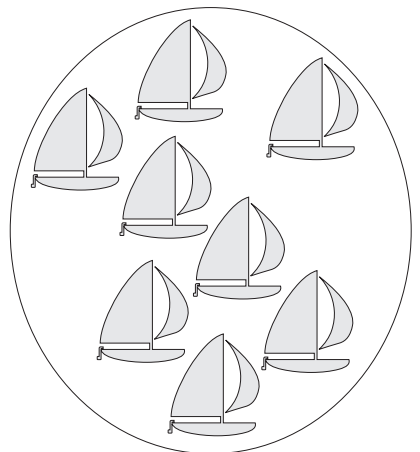

□

Meitseáil iad seo agus dathaigh iad.

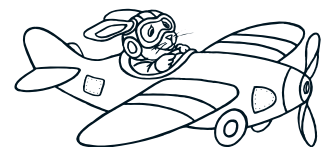
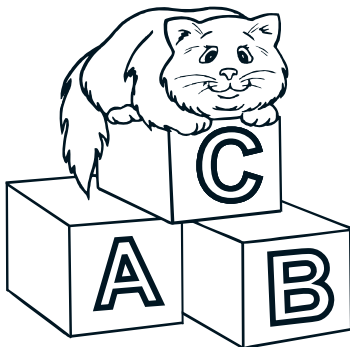
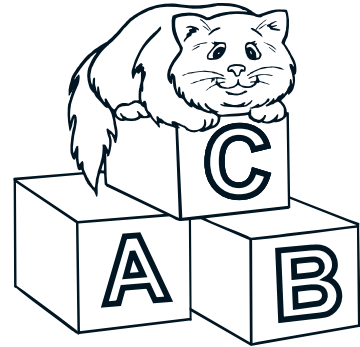
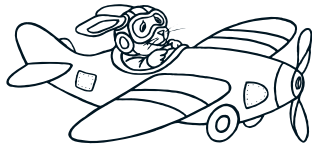



cat



síota



seilide

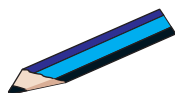

Is é an _____ an t-ainmhí is tapúla.

Cén aois?

Tá Seán ___ bliana d'aois.

Tá Síle ___ bliana d'aois

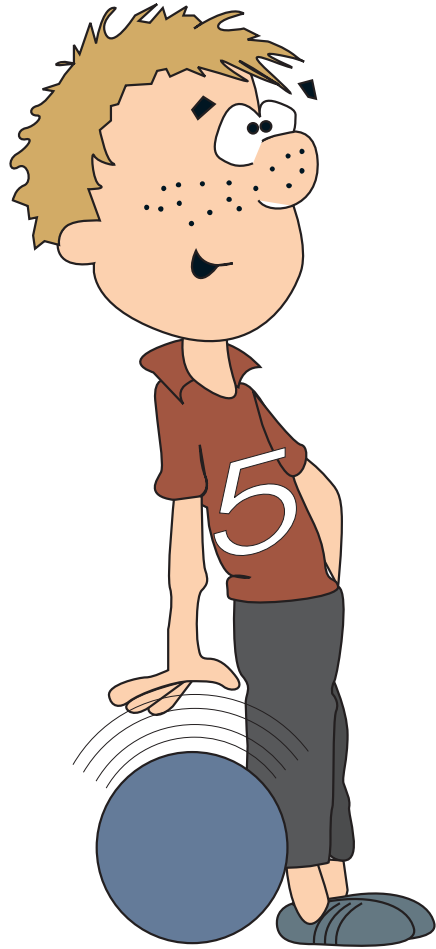

Táimse ___ bliana d'aois

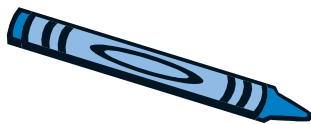

Scéal a Cúig

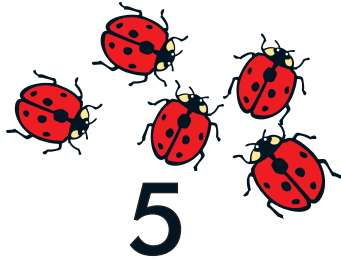

5

+

0

=



4

+



1

=



3

+



2

=



2

+



3

=



1

+

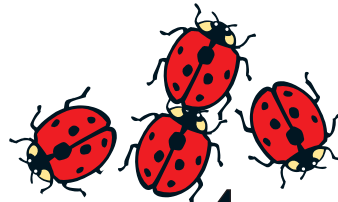

4

=

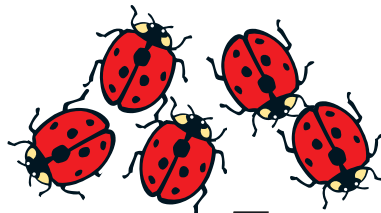

0

+

5

=

Cuir líne timpeall ar na focail atá ar eolas agat.

Síle a haon Seán

a dó

ceangail poncanna

cearnóg

tarraing

suimigh

triantán

a cúig

a hocht

a trí

a seacht

a sé

a Naoi

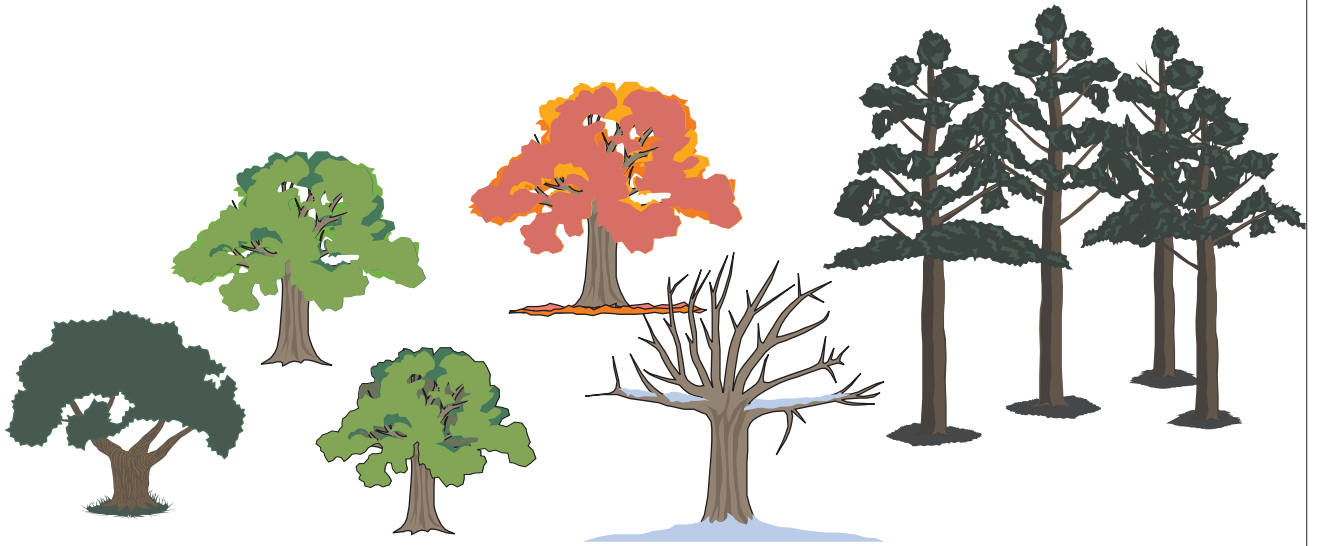
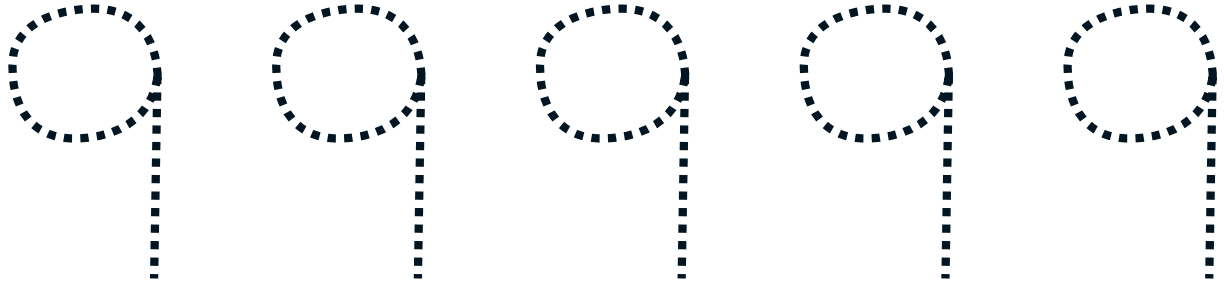
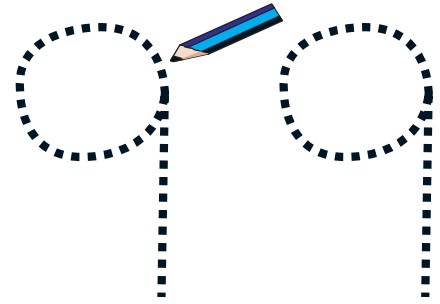
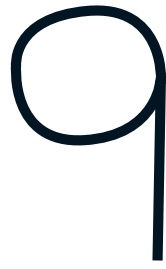

Naoi gcinn

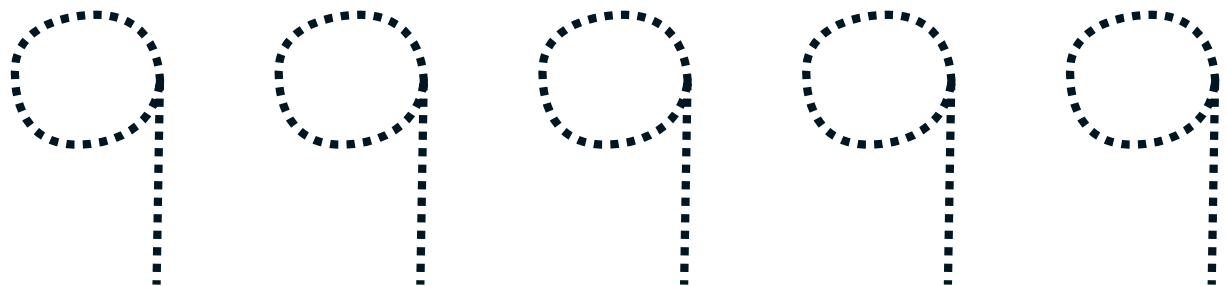

Cé mhéad rud i ngach tacar?

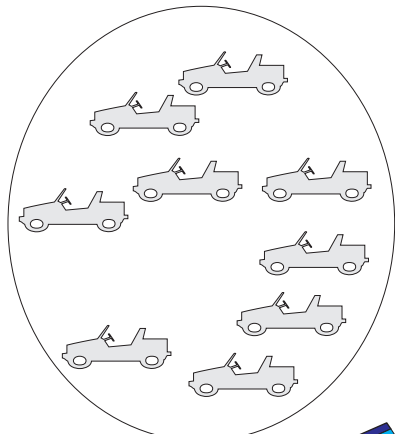

10 toy cars are arranged in a circle. Below the circle is a small square box for the answer. A pencil is positioned to the right of the box.

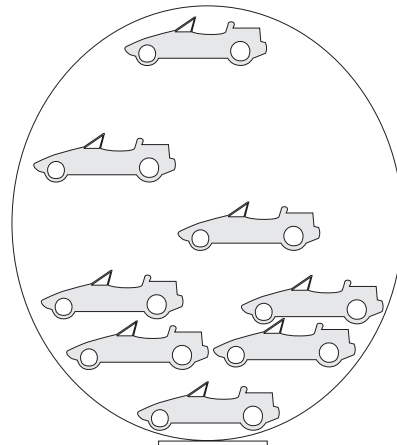

8 toy cars are arranged in a circle. Below the circle is a small square box for the answer.

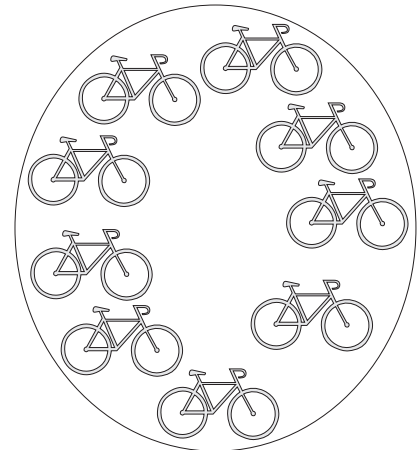

10 bicycles are arranged in a circle. Below the circle is a small square box for the answer.

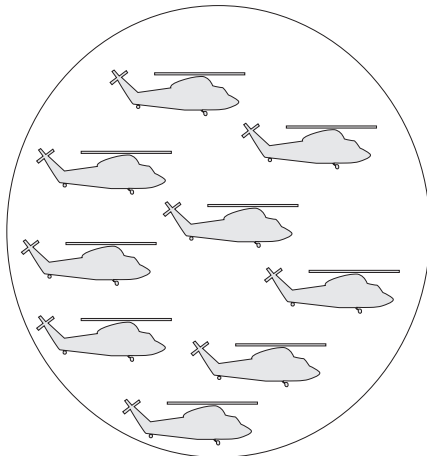

10 helicopters are arranged in a circle. Below the circle is a small square box for the answer.

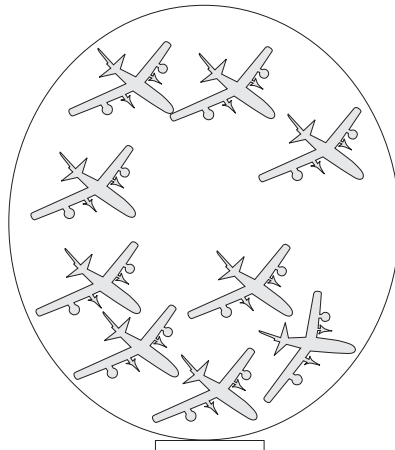

10 airplanes are arranged in a circle. Below the circle is a small square box for the answer.

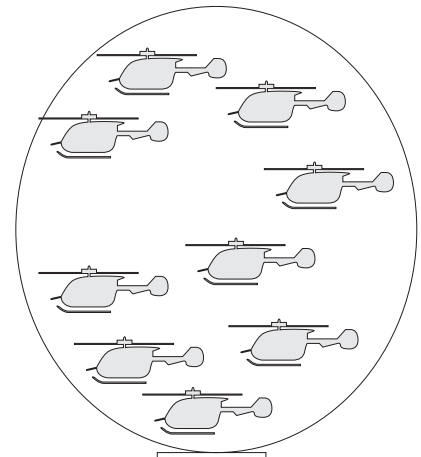

10 submarines are arranged in a circle. Below the circle is a small square box for the answer.

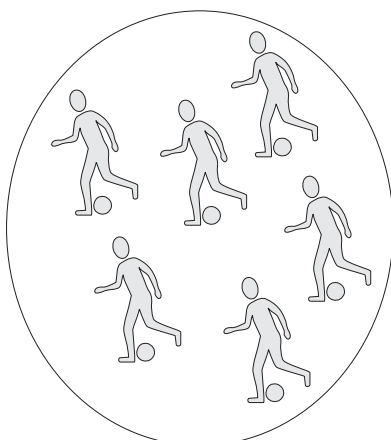

8 soccer players are arranged in a circle. Below the circle is a small square box for the answer.

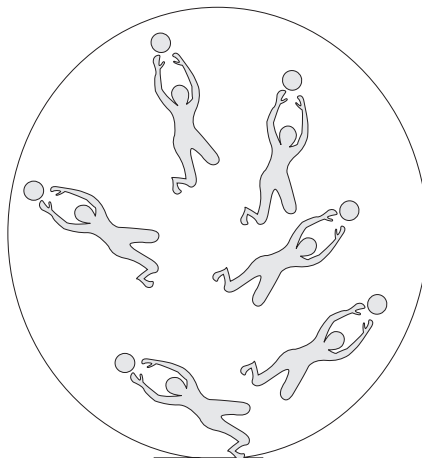

8 basketball players are arranged in a circle. Below the circle is a small square box for the answer.

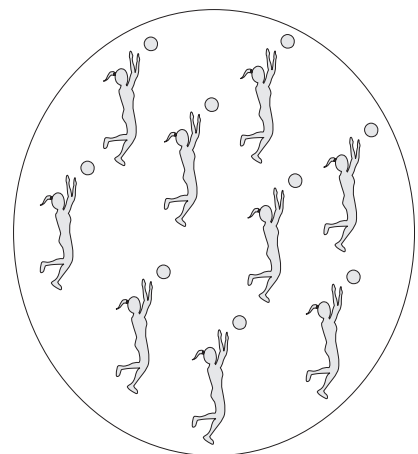

10 basketball players are arranged in a circle. Below the circle is a small square box for the answer.

Tomás



Liam

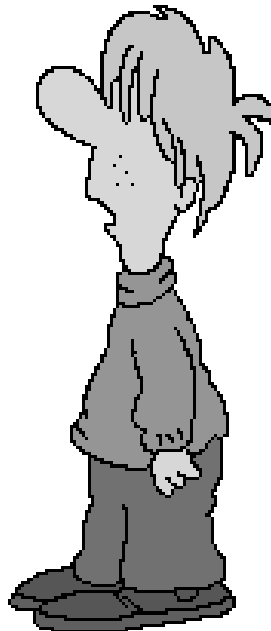

Darach



Is é _____ is airde.

Is é _____ is lú.

Ceangail na poncanna agus dathaigh an pictiúr.

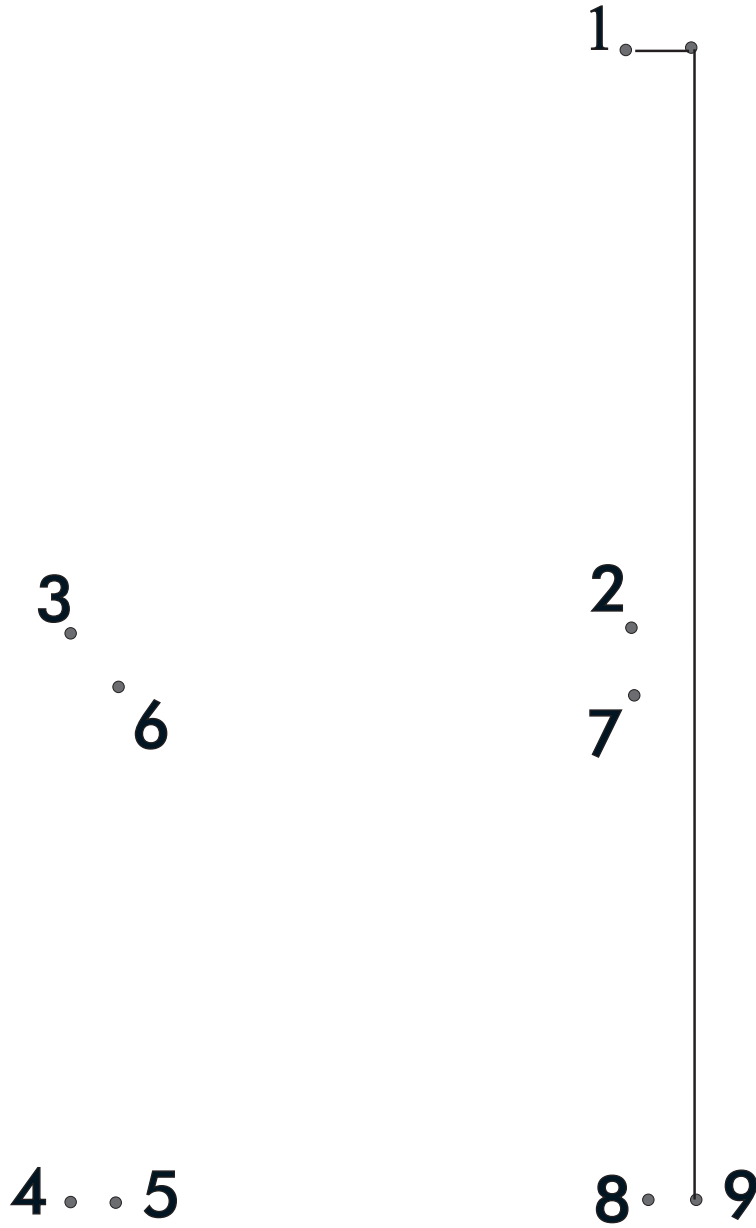

Ceangail na poncanna agus dathaigh an pictiúr.



3 • 4

7 • 8

Ceangail na poncanna agus dathaigh an pictiúr.

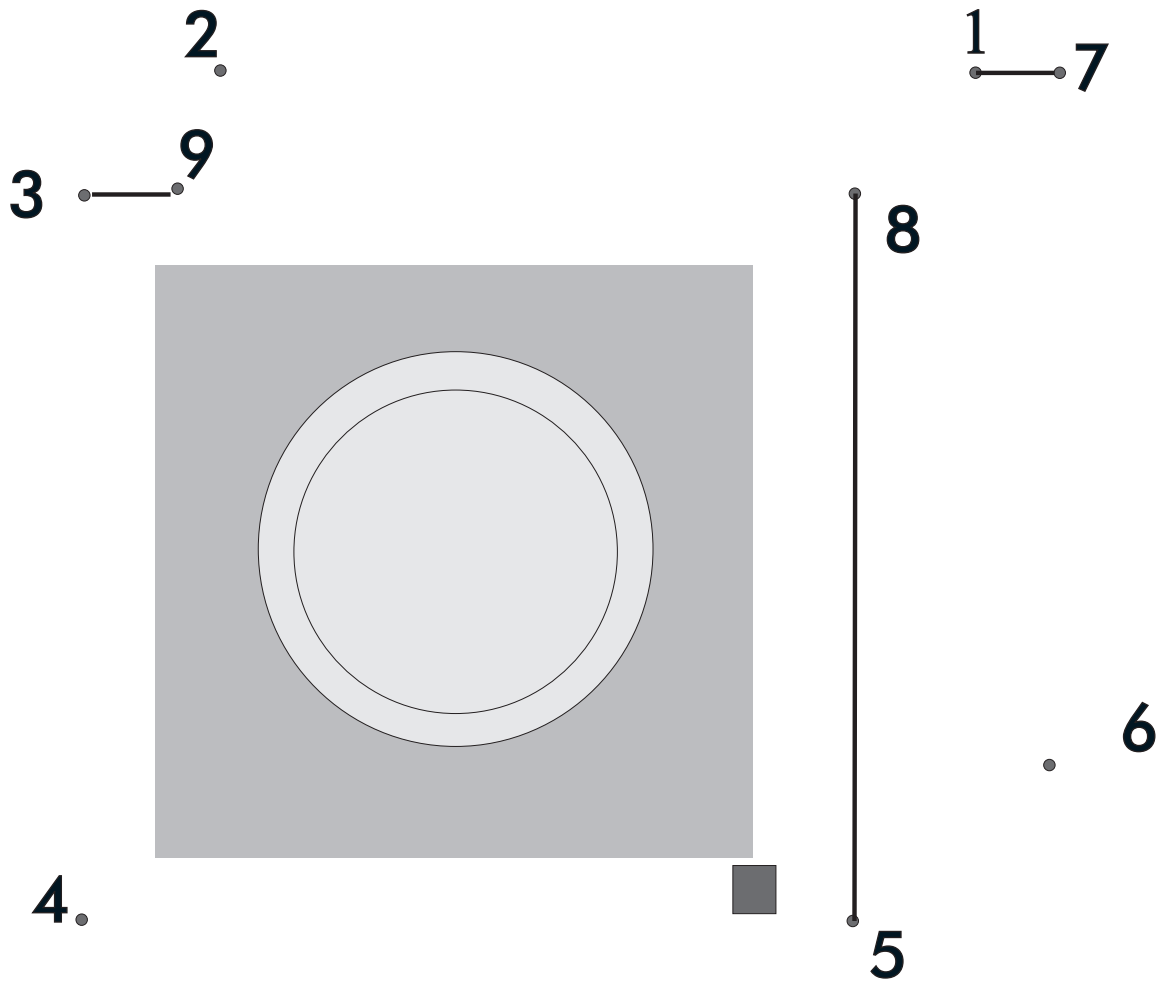

Ceangail na poncanna agus dathaigh an pictiúr.

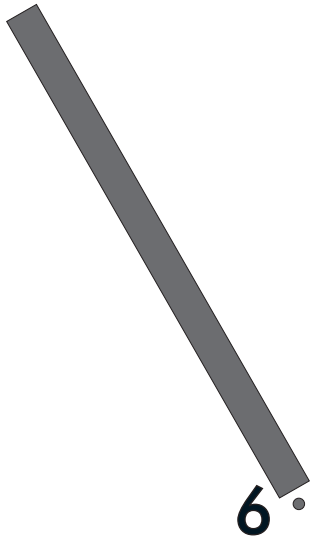

• 4

• 5

7 •

8

2



• 3

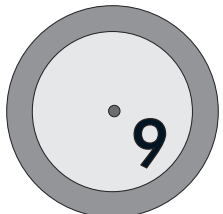
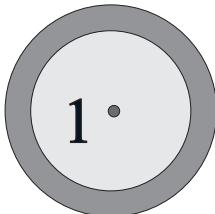

Ceangail na poncanna agus dathaigh an pictiúr.

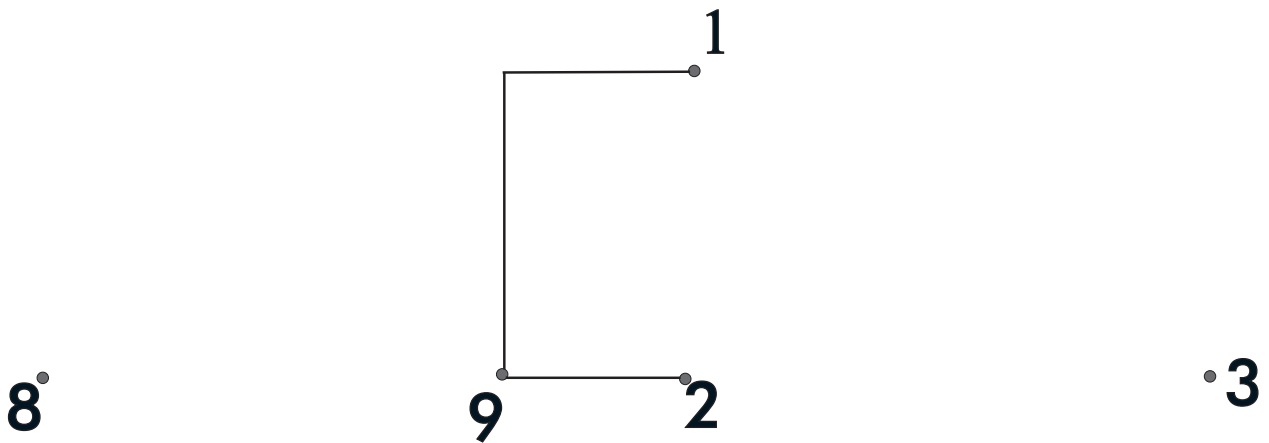
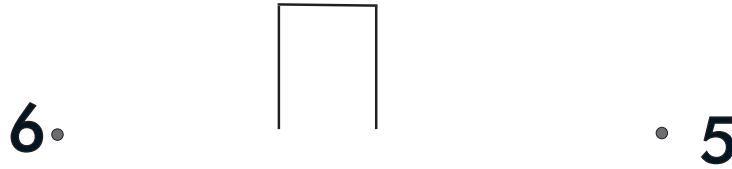

Ceangail na poncanna agus dathaigh an pictiúr.

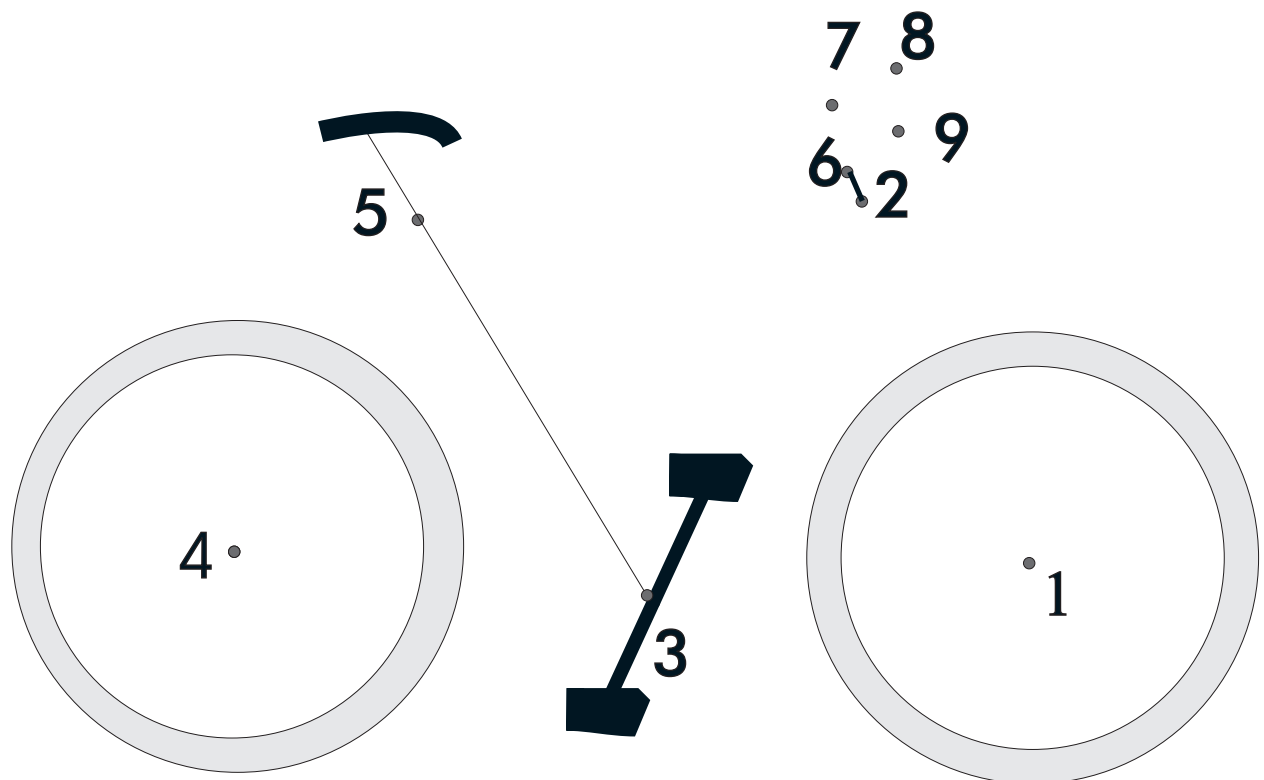

Meaitseáil iad seo.

0
1
2
3
4
5
6
7
8
9

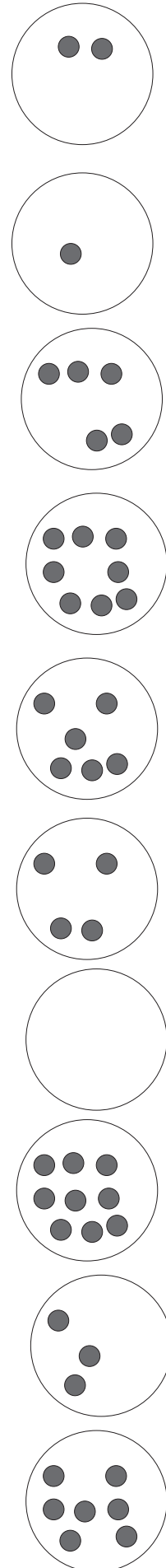

Cé mhéad spota?

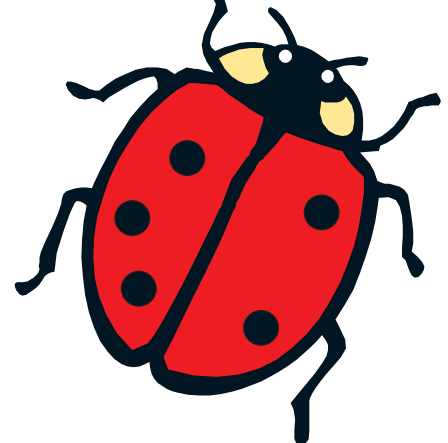
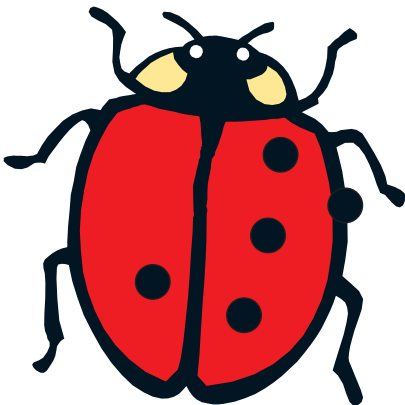
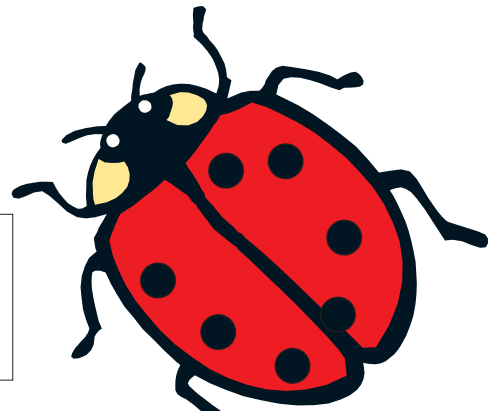
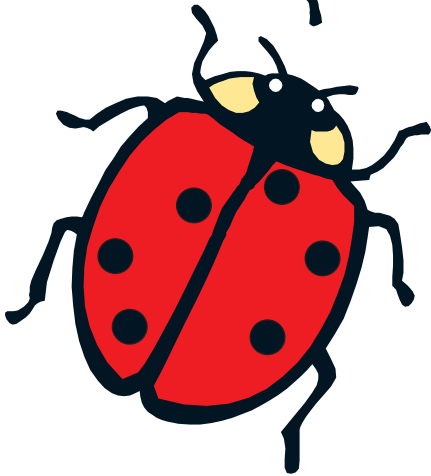
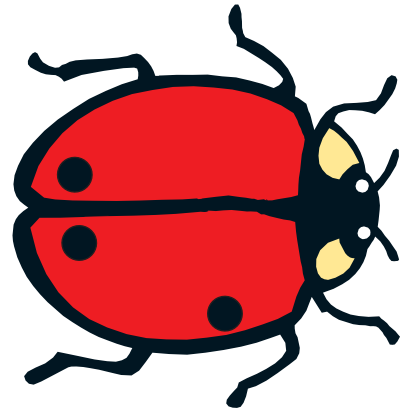
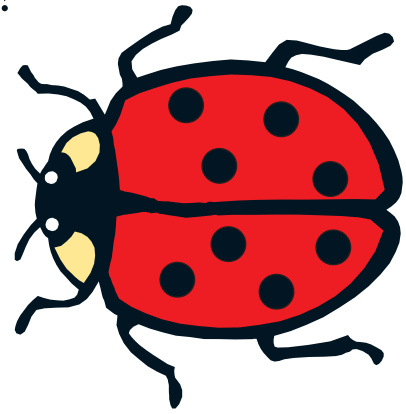
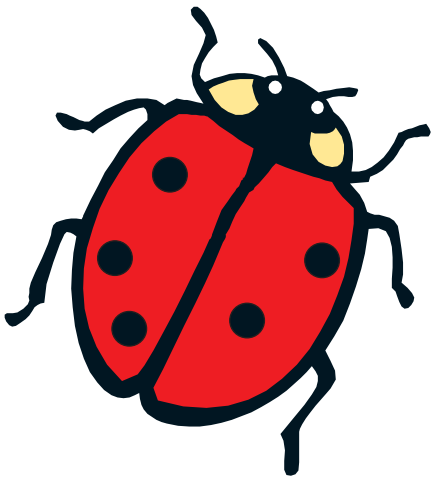

Líon na bearnaí.

1	2			5		7		9
---	---	--	--	---	--	---	--	---

			4					
--	--	--	---	--	--	--	--	--

		3					8	
--	--	---	--	--	--	--	---	--

			4					
--	--	--	---	--	--	--	--	--

				5				
--	--	--	--	---	--	--	--	--

					6			
--	--	--	--	--	---	--	--	--

Líon na bearnaí.

céim

an naoú céim
an _____ú céim

an t-ochtú céim
an _____ú céim

an seachtú céim
an _____ú céim

an séú céim
an _____ú céim

an cúigiú céim
an _____ú céim

an ceathrú céim
an _____ú céim

an tríú céim
an _____ú céim

an dara céim
an _____ú céim

an chéad chéim
an _____ú céim

Ceangail na poncanna agus dathaigh an pictiúr.

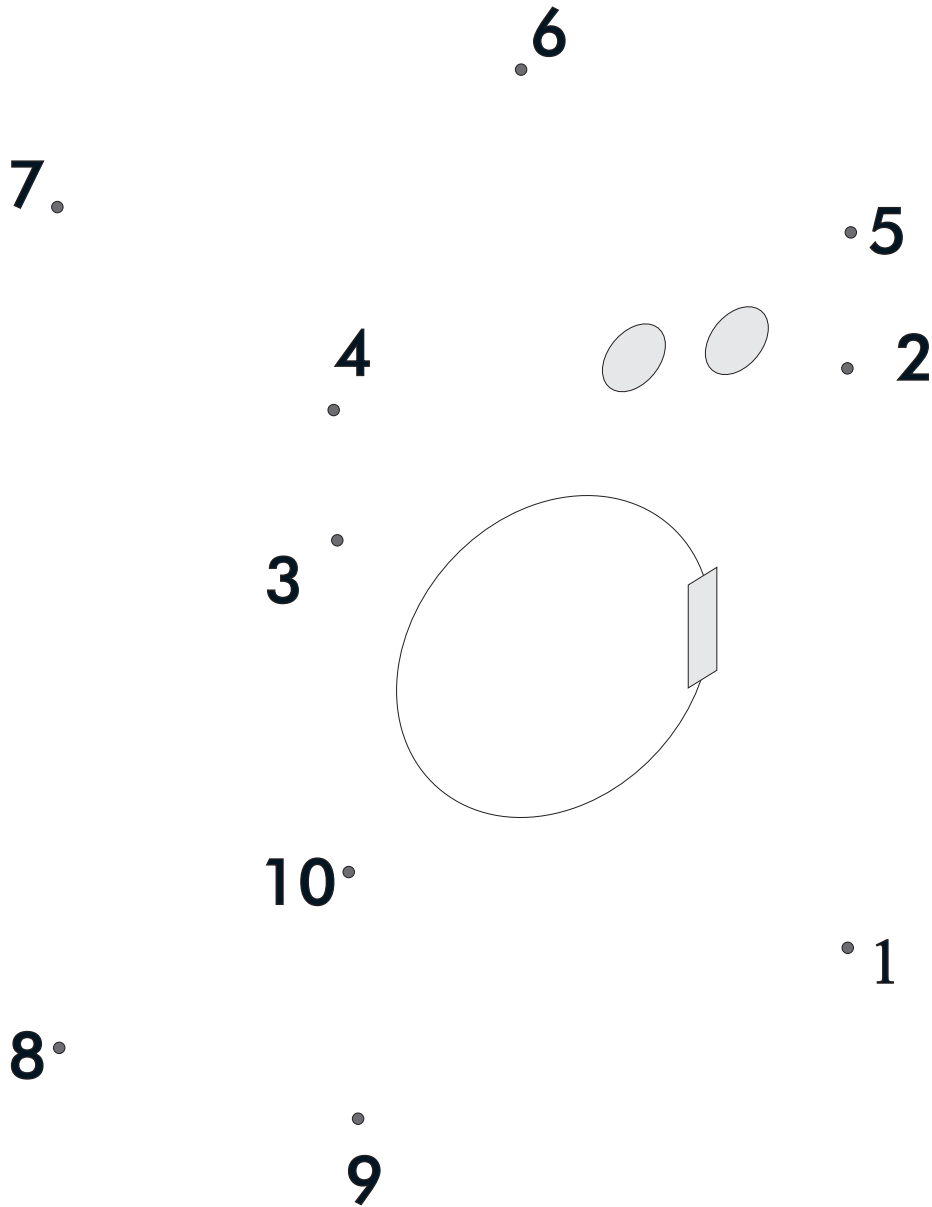

Ceangail na poncanna agus dathaigh an pictiúr.

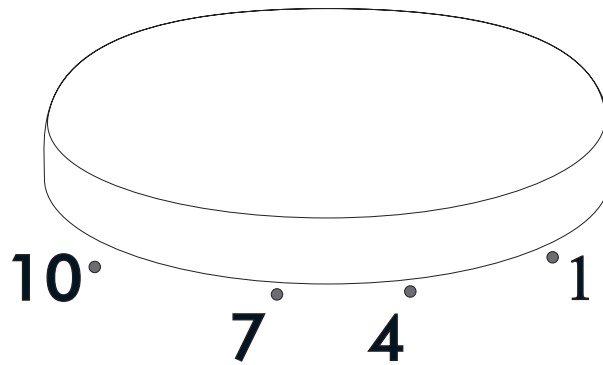

9 · 8

3 · 2

6 · 5

Ceangail na poncanna agus dathaigh an pictiúr.

10.

.1

9..2

7.
.
6

8..3

.4
.
5

Mór nó beag?

‘Tá mise **an-mhór**,’ arsa an cat.



‘Níl,’ arsa an madra
agus sheas sé suas.



‘Tá an cat **an-bheag**,

Ach tá an *madra* **an-mhór**.’

‘Níl,’ arsa an bhó
agus sheas sí suas.

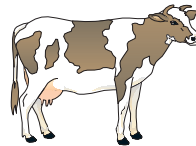

‘Tá an madra **an-bheag**,

Ach tá an *bhó* **an-mhór**.’

‘Níl’, arsa an capall
agus sheas sé suas.

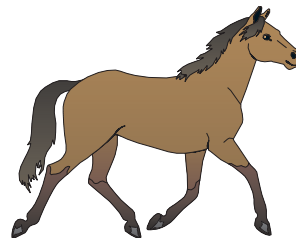

‘Tá an bhó **an-bheag**,

Ach tá an *capall* **an-mhór**.’

‘Féach *suas*,’ arsa an eilifint

‘is tá tú beag.

Féach *síos*

agus tá tú **mór**.’



Scéal a Sé

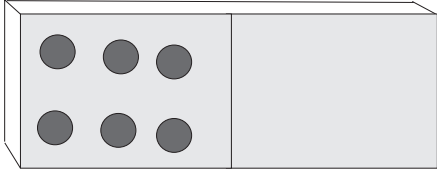

$6 + 0 = 6$

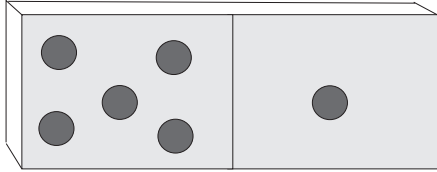

$\square + \square = 6$

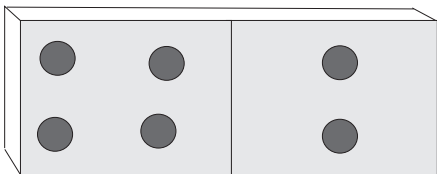

$\square + \square = 6$

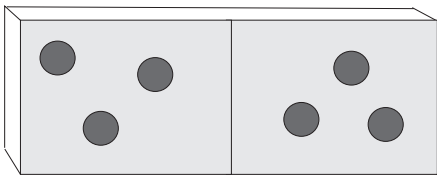

$\square + \square = 6$

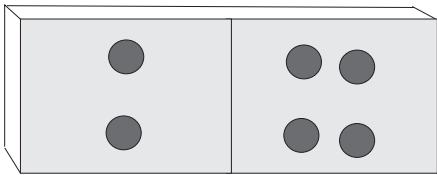

$\square + \square = 6$

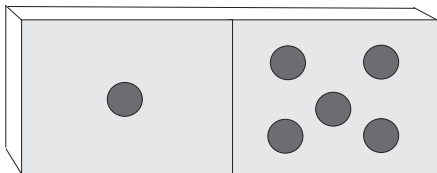

$\square + \square = 6$

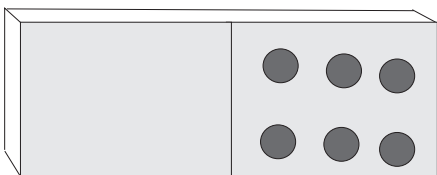

$\square + \square = 6$

Leathan agus Cúng

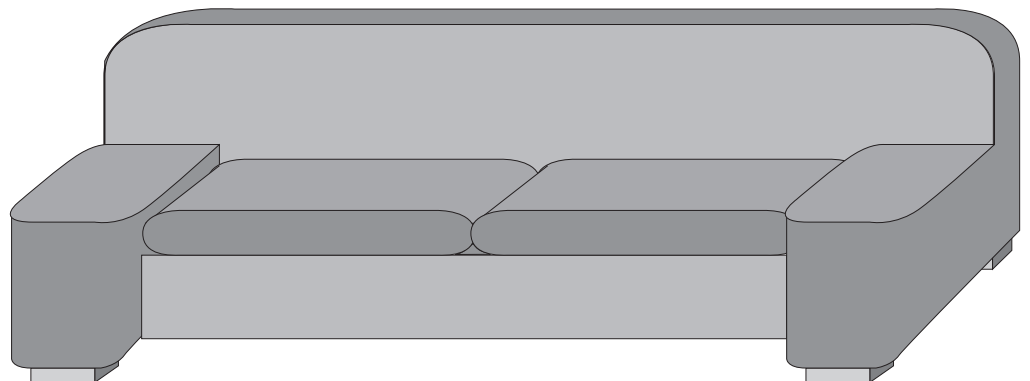
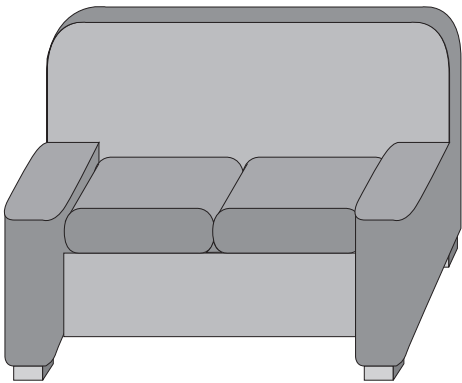
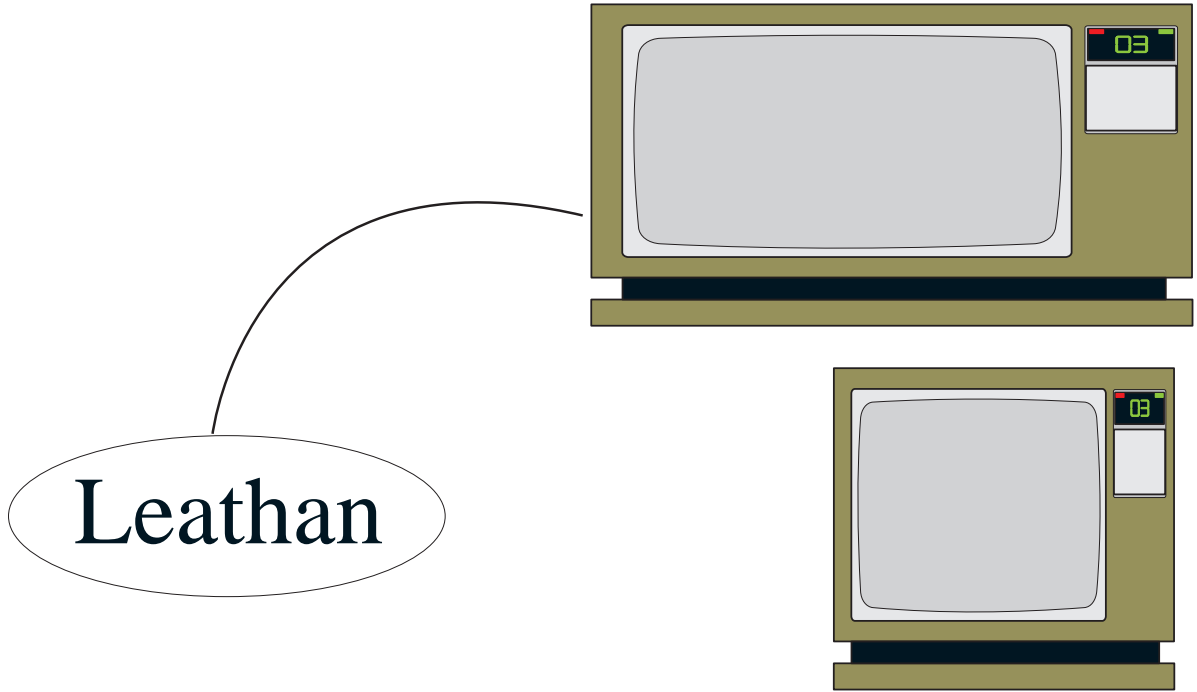

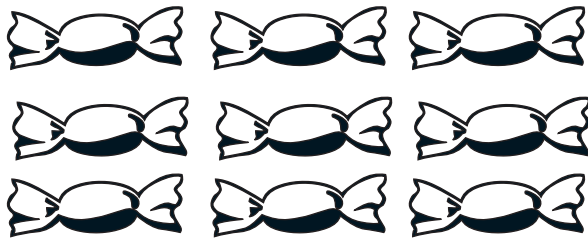

Ith ceann
amháin (1).

fágtha

Ith ceann
amháin (1) eile.

fágtha

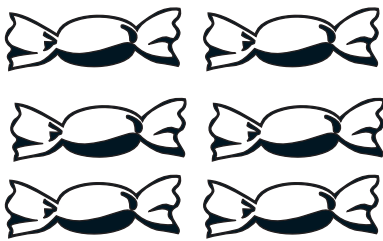

Ith ceann
amháin (1).

fágtha

Ith ceann
amháin (1) eile.

fágtha

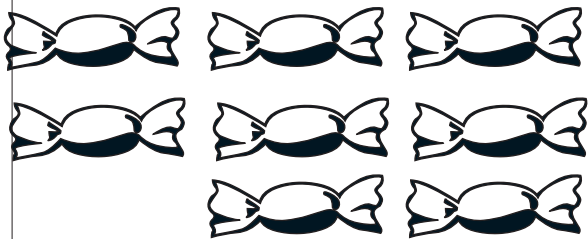

Ith ceann
amháin (1).

fágtha

Ith ceann
amháin (1) eile.

fágtha

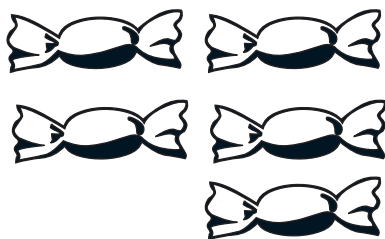

Ith ceann
amháin (1).

fágtha

Ith ceann
amháin (1) eile.

fágtha



dronuilleog

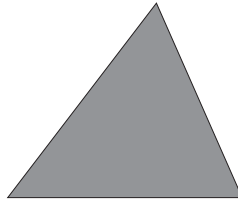

triantán



cearnóg

1.

.4

l.

.4

2.

.3

2.

.3

dro



cea

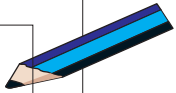

3.

.l

2.

.3

l.

.2

[Empty box for writing]



[Empty box for writing]



Dathaigh mé!

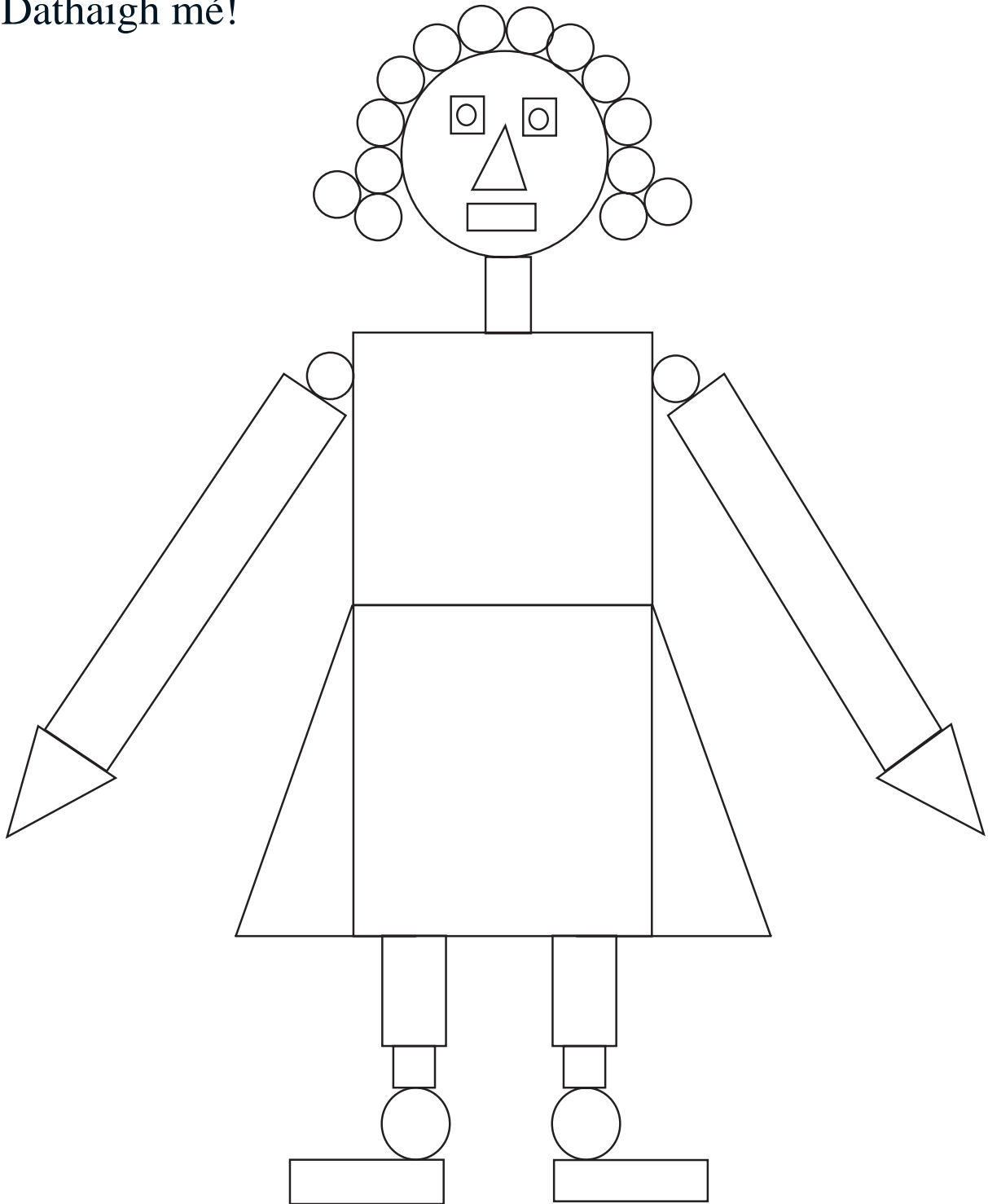

			
glas	dearg	gorm	buí

Snámhann sé



Ní shnámhann sé

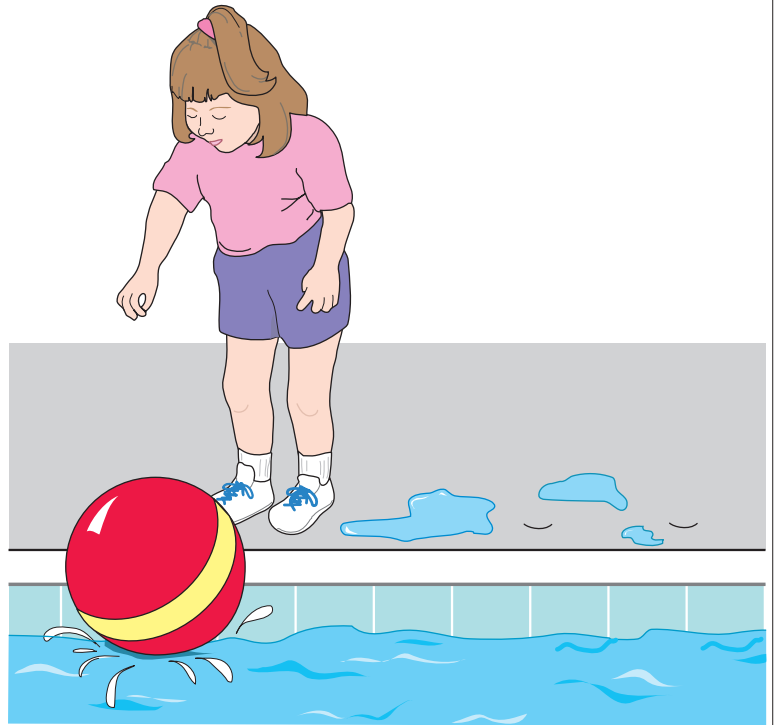
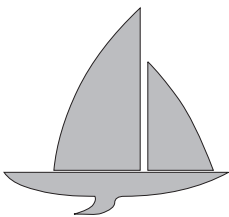
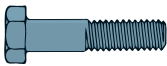
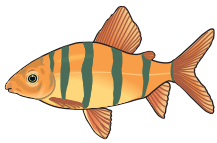
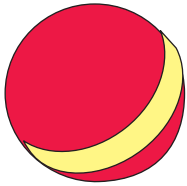

Scéal a Seacht

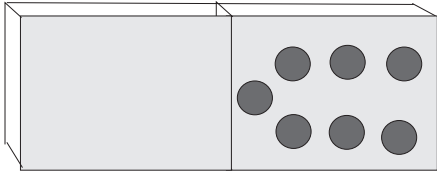

$0 + 7 = 7$

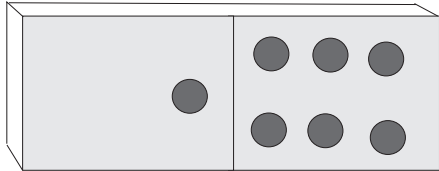

$\square + \square = 7$

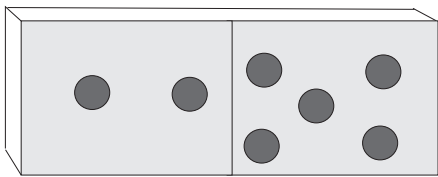

$\square + \square = 7$

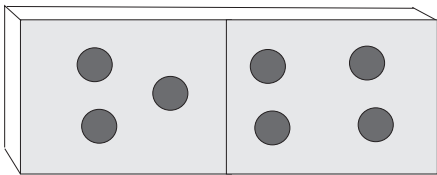

$\square + \square = 7$

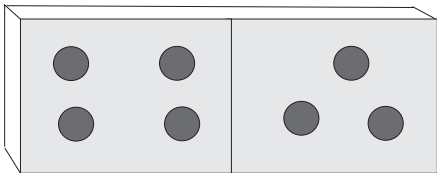

$\square + \square = 7$

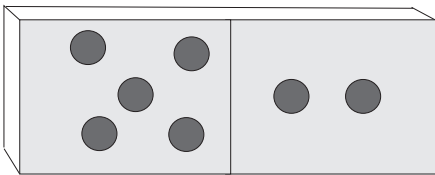

$\square + \square = 7$

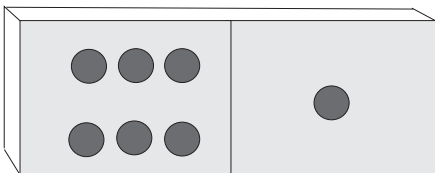

$\square + \square = 7$

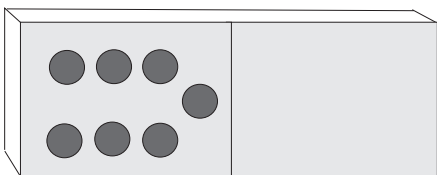

$\square + \square = 7$



thar



faoin scáth báistí

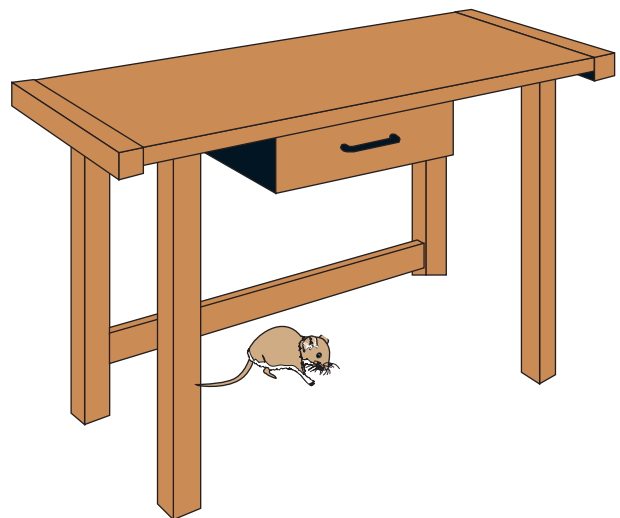

Tá an luchóg _____ mbord.

a Deich 10

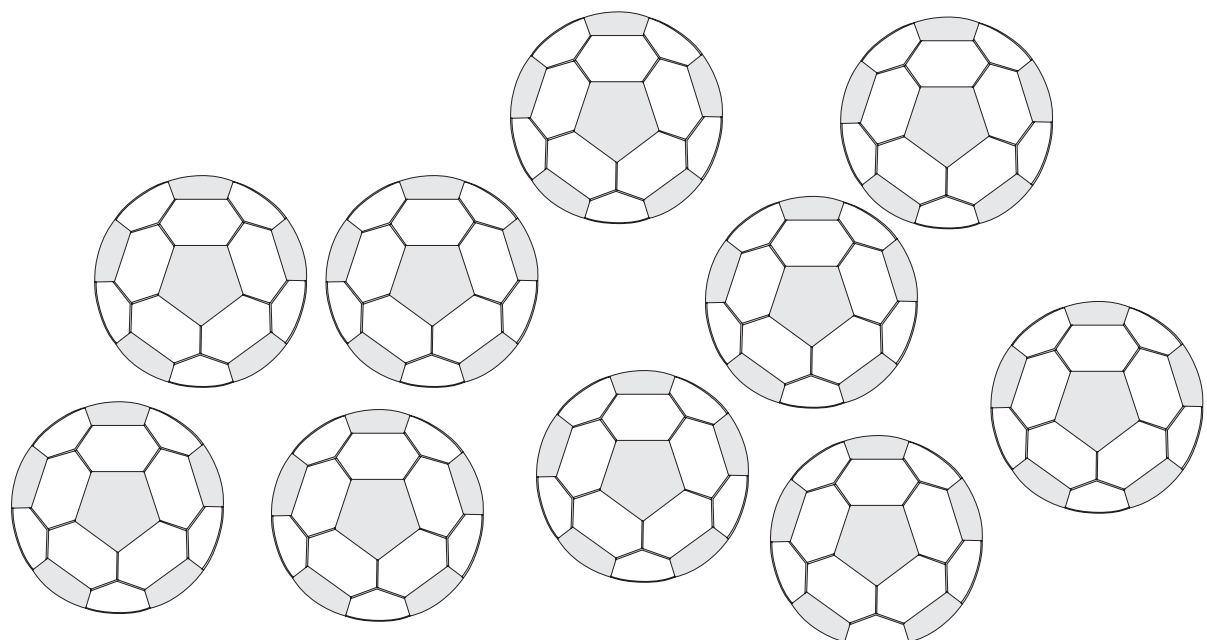
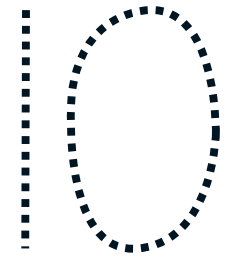
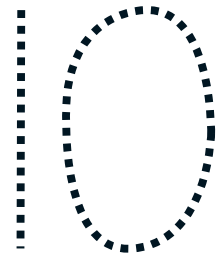
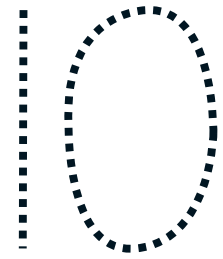
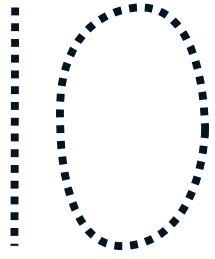
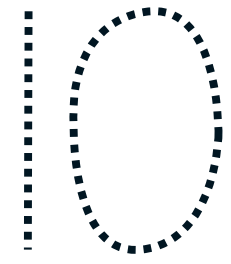
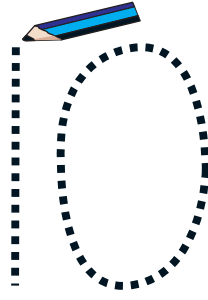

Deich gcinn

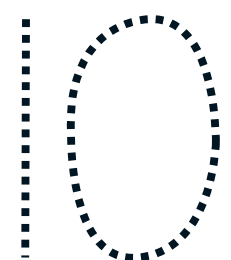
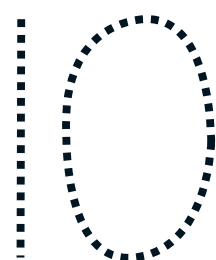
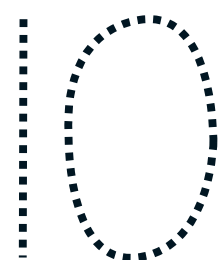
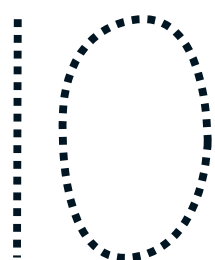

Cé mhéad rud i ngach tacar?

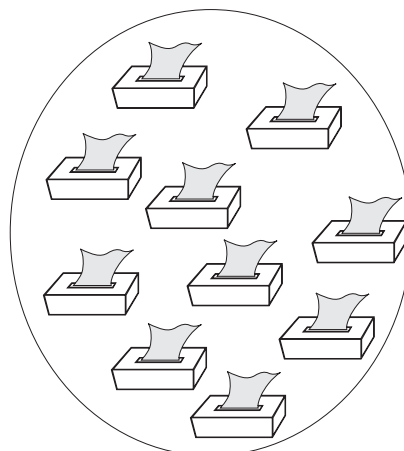
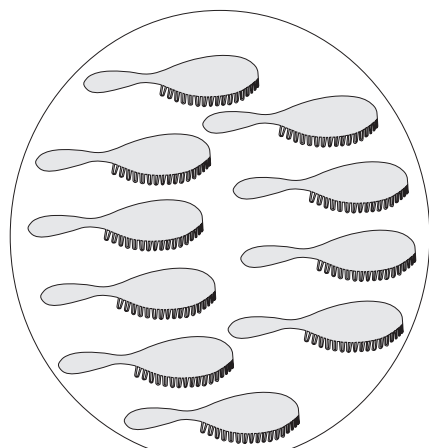
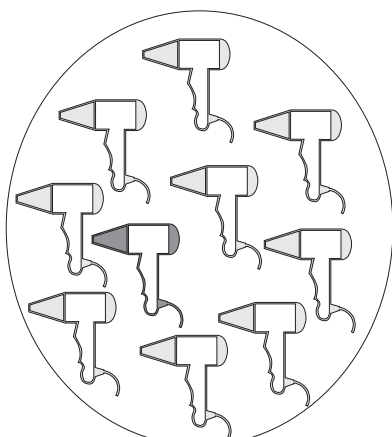
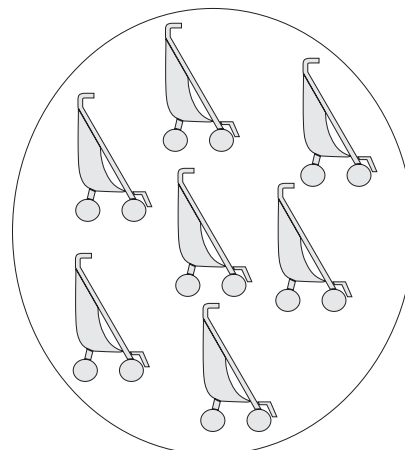
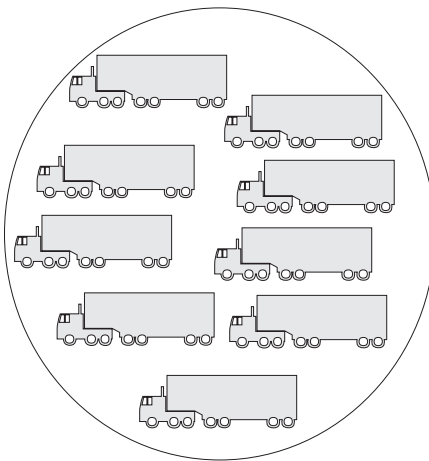
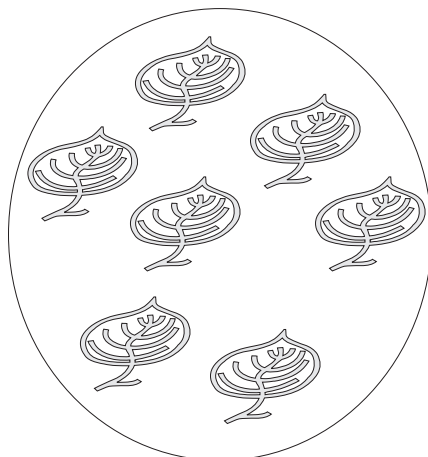
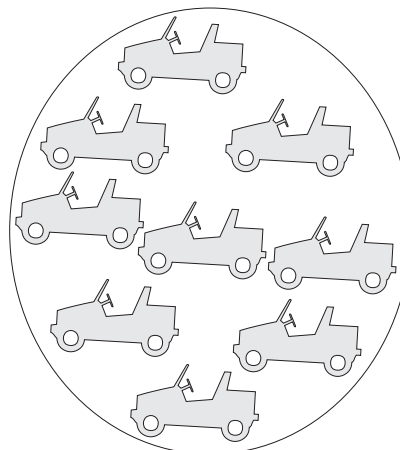
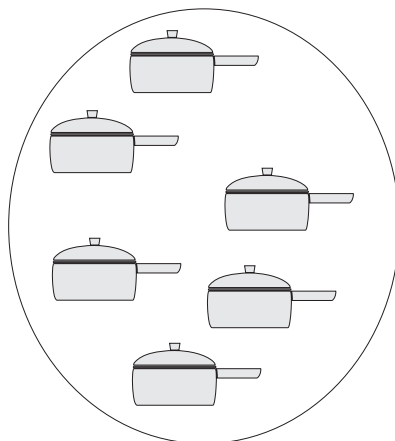
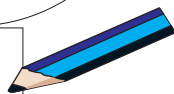
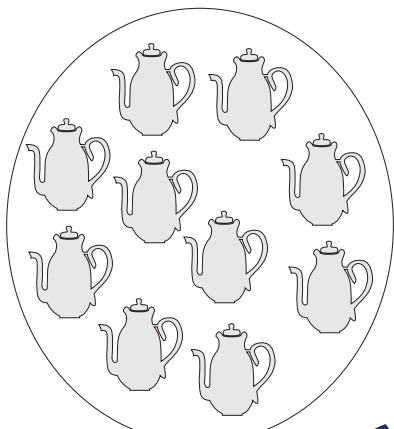

Cuir an líon ceart milseán sna prócaí.

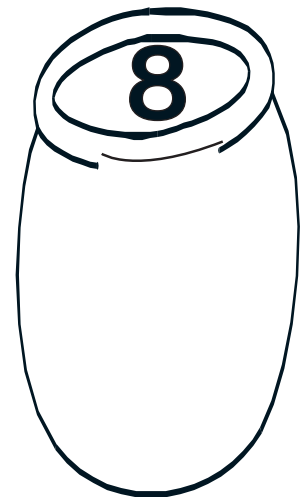
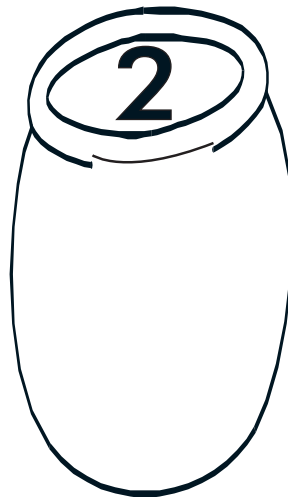
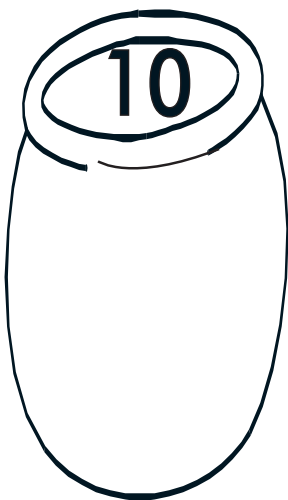
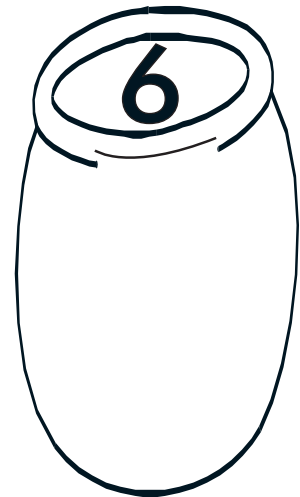
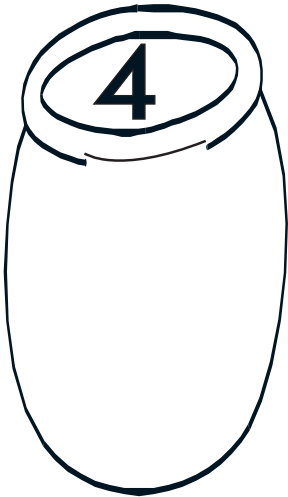
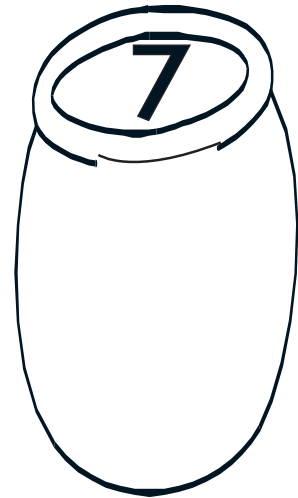
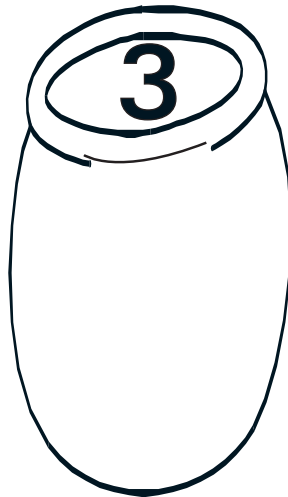
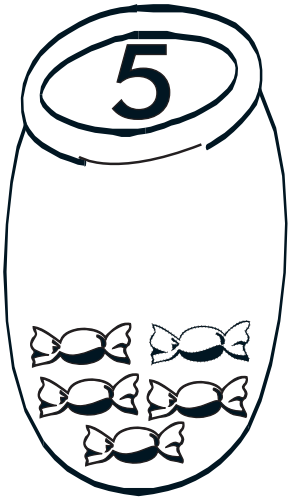

Tarraing ubh i ngach ubhchupán.

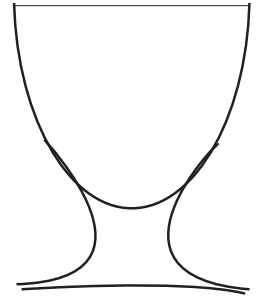
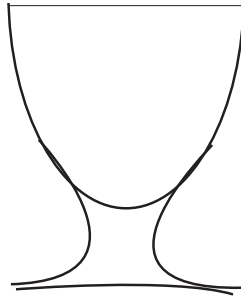
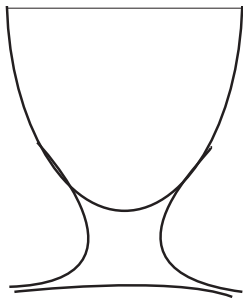

Cé mhéad ar gach ceann?



8 cent

__ cent an ceann

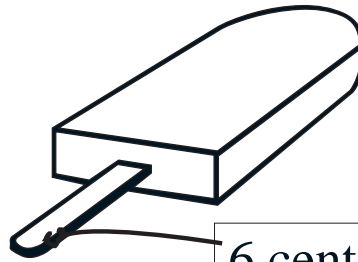

6 cent

__ cent an ceann

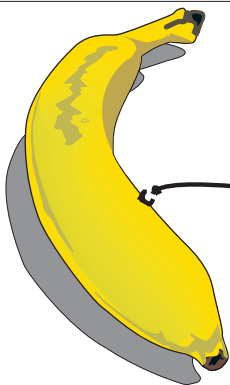

9 cent

__ cent an ceann



5 cent

__ cent an ceann

Scéal a hOcht

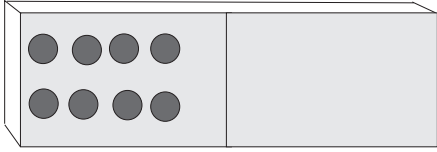

$$\square + \square = 8$$

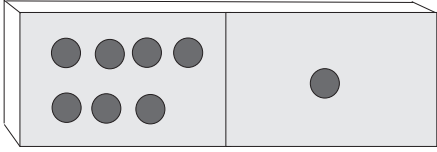

$$\square + \square = 8$$

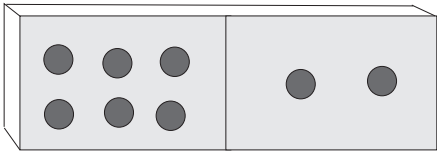

$$\square + \square = 8$$

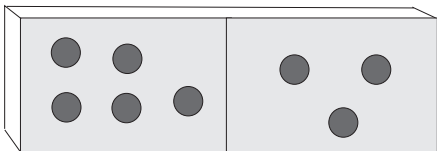

$$\square + \square = 8$$

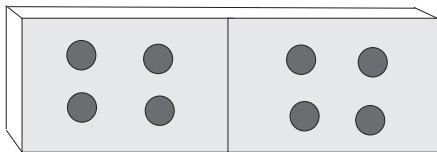

$$\square + \square = 8$$

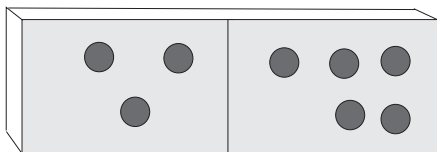

$$\square + \square = 8$$

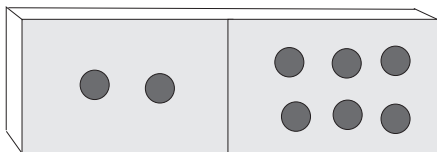

$$\square + \square = 8$$

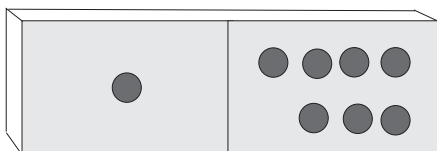

$$\square + \square = 8$$

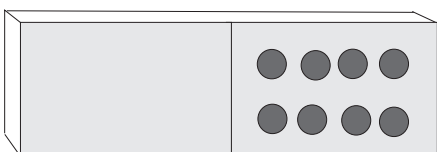

$$\square + \square = 8$$

Cé mhéad rud i ngach tacar?

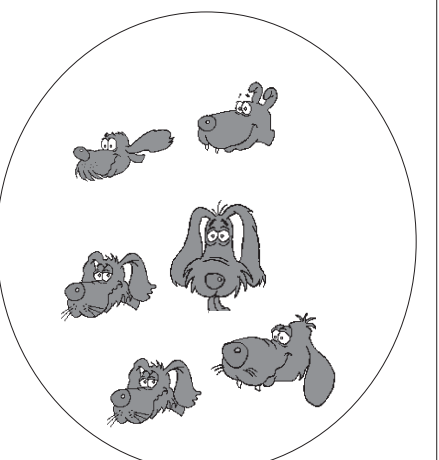
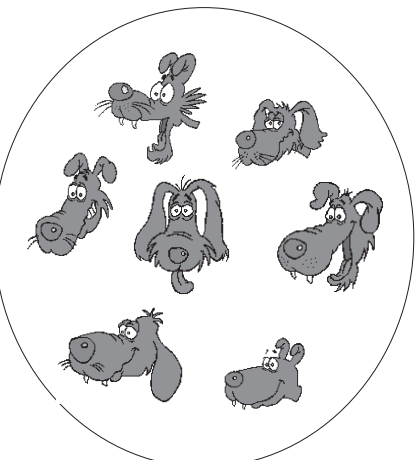
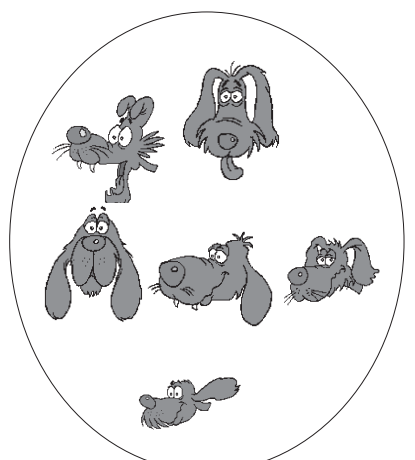
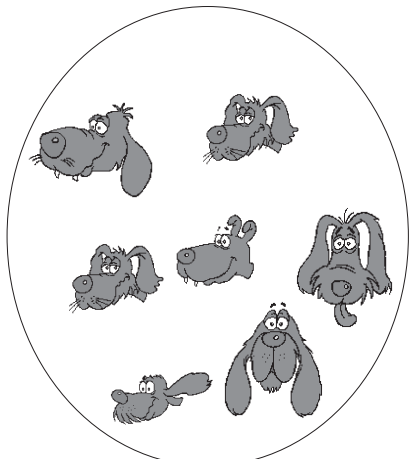
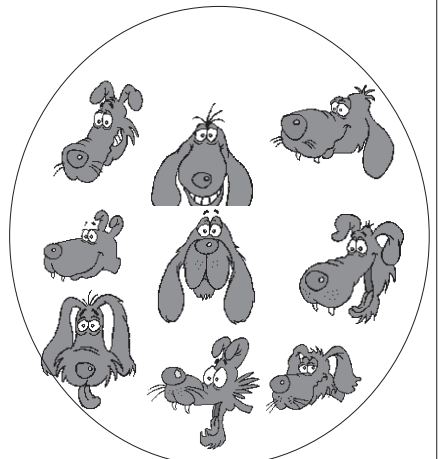
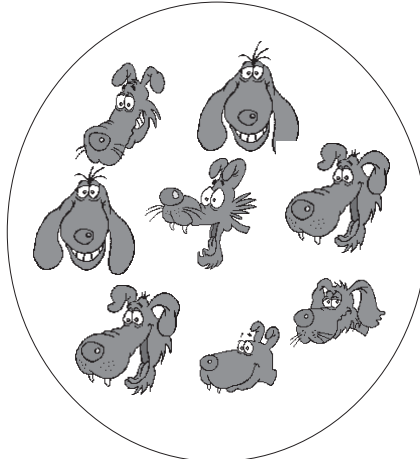

Tarraing an lámh bheag ar an gclog.

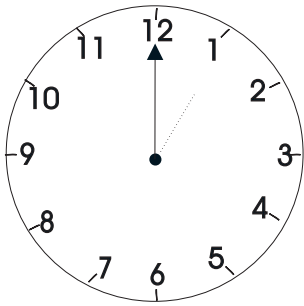

1 a chlog

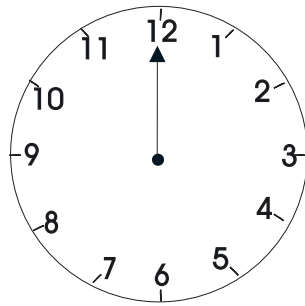

2 a chlog

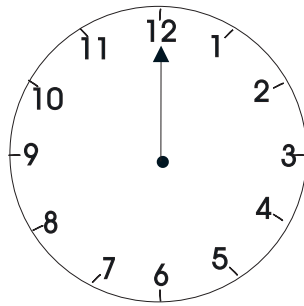

3 a chlog

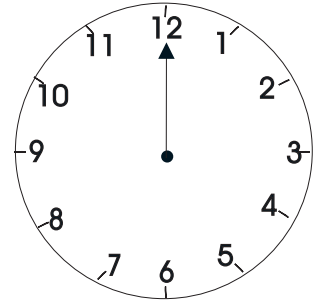

4 a chlog

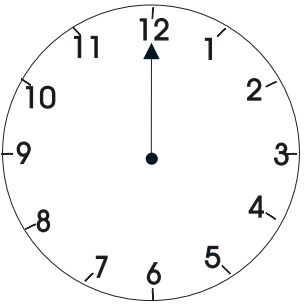

5 a chlog

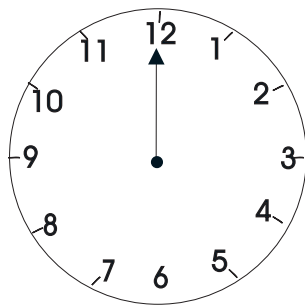

6 a chlog

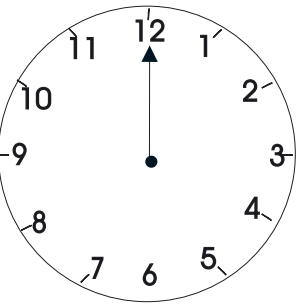

7 a chlog

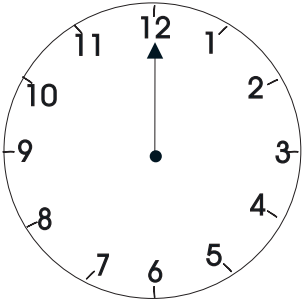

8 a chlog

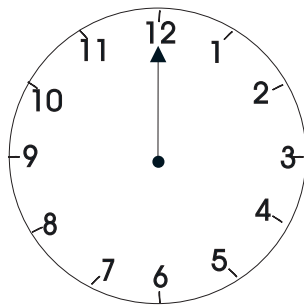

9 a chlog

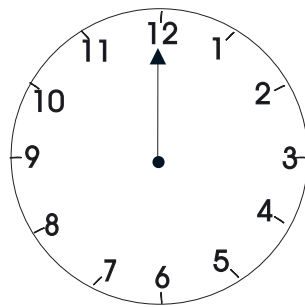

10 a chlog

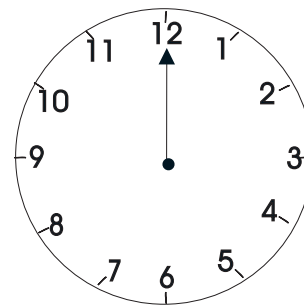

11 a chlog

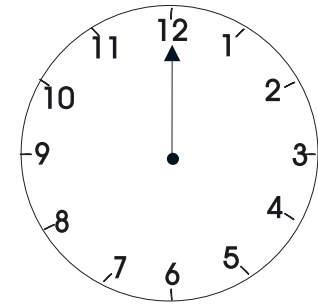

12 a chlog

an líon is lú
an líon is mó



Ag Lúlú atá an líon is ____.

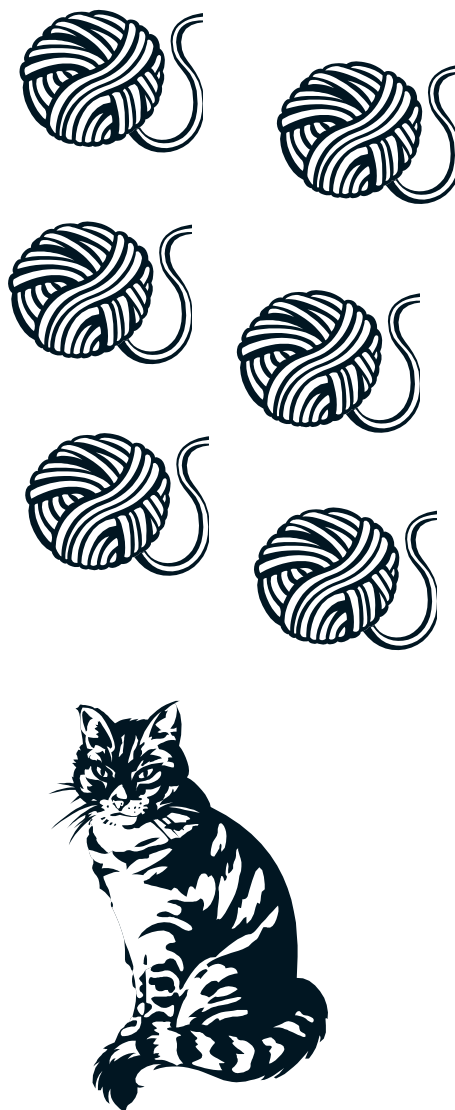

Ag Tíogar atá an líon is ____.

trom
éadrom

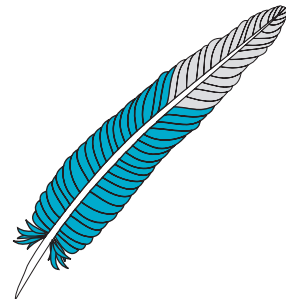
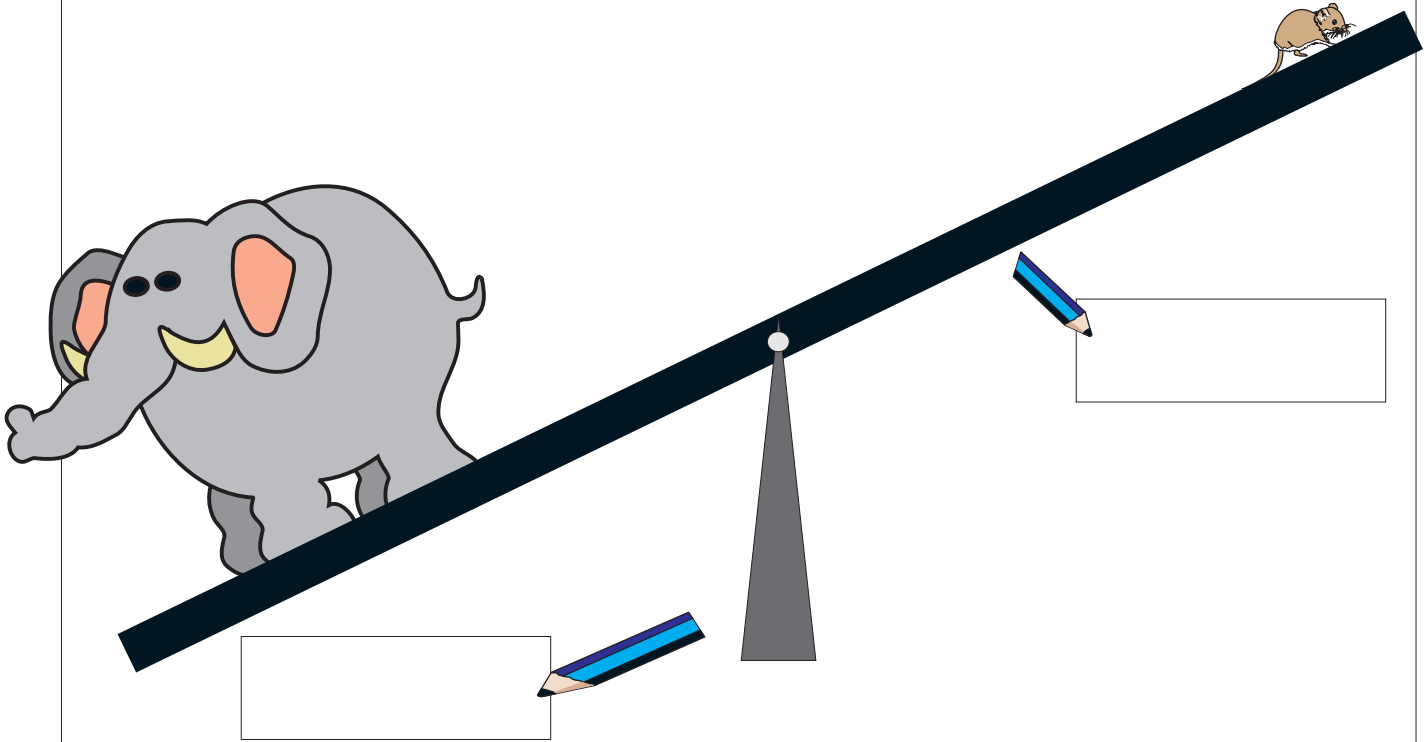

lán
folamh

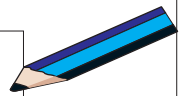
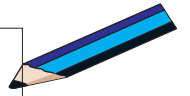
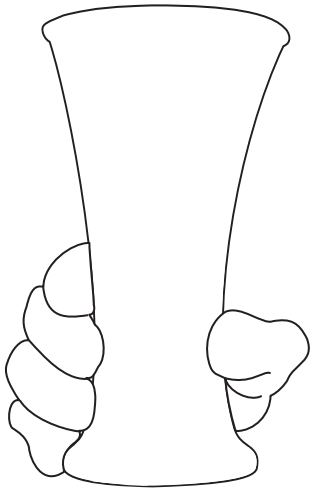

caol leathan

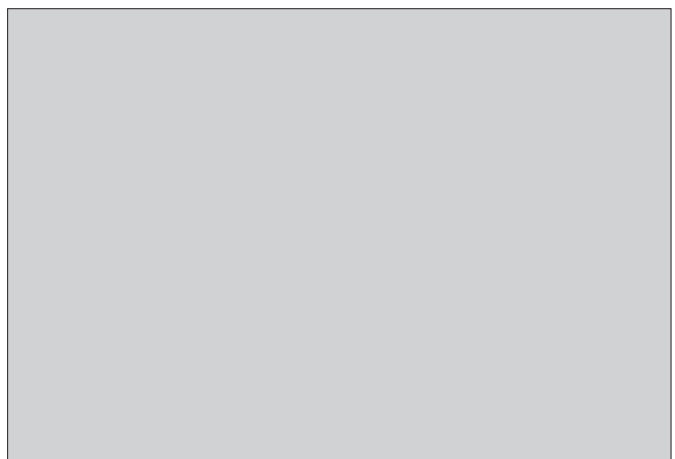
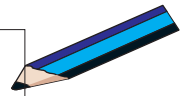
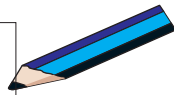
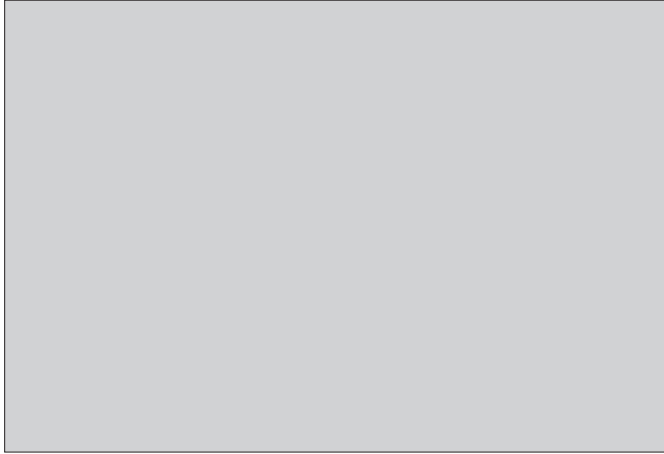

difriúil mar a chéile

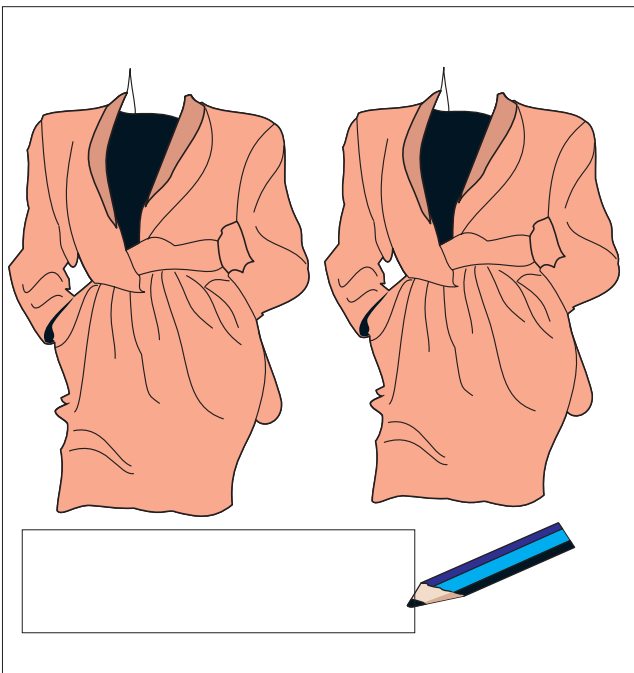

beagán go leor

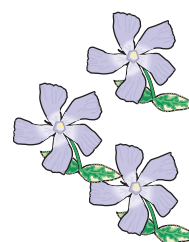
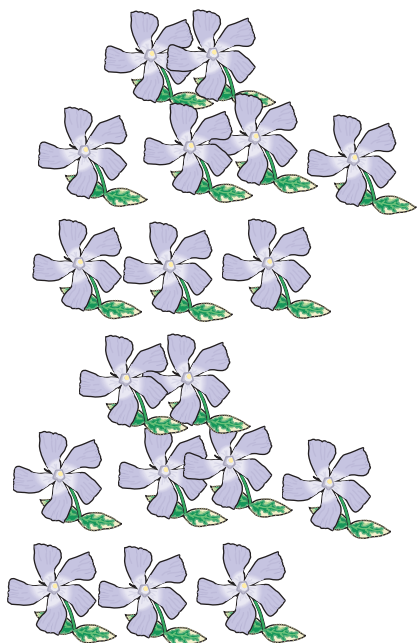

iomlán
leath

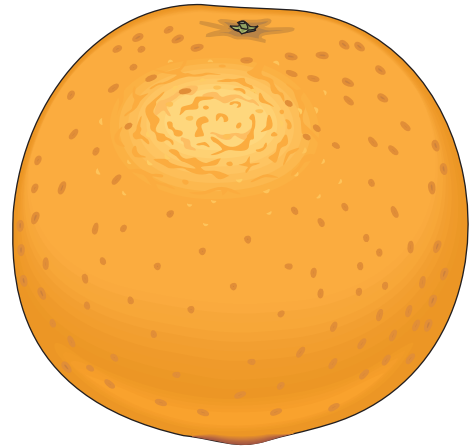
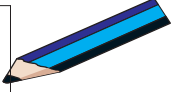
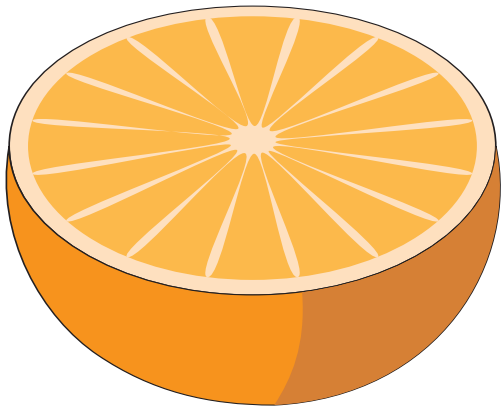

dosaen
leathdosaen

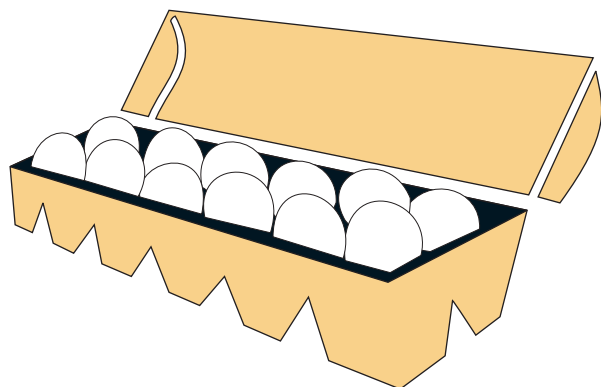
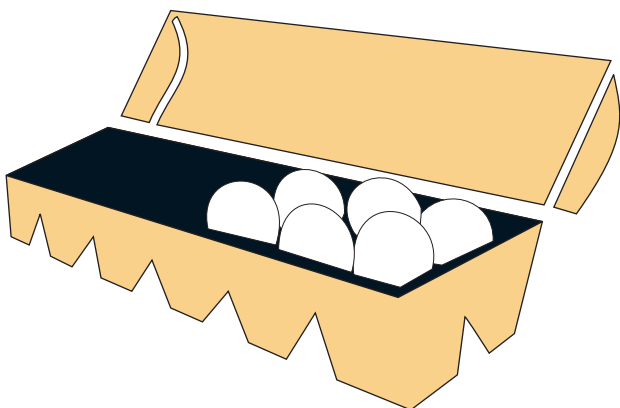

Cártaí Teanga

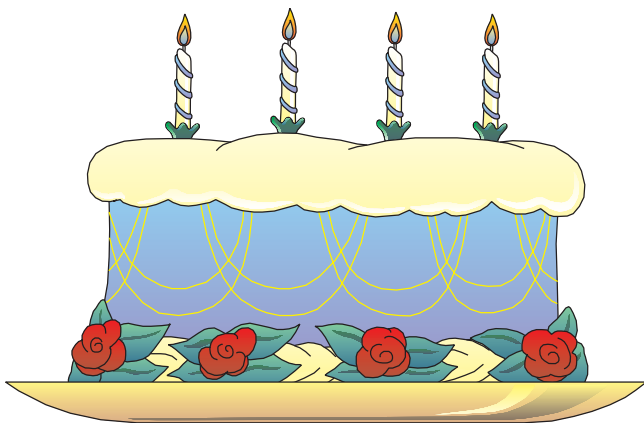
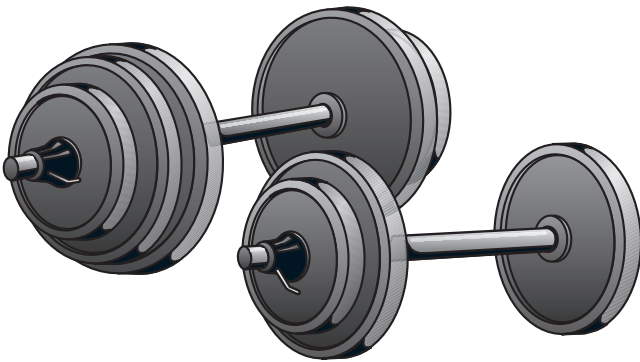
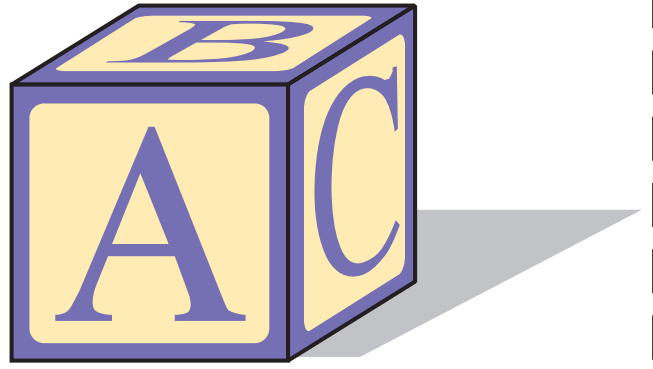
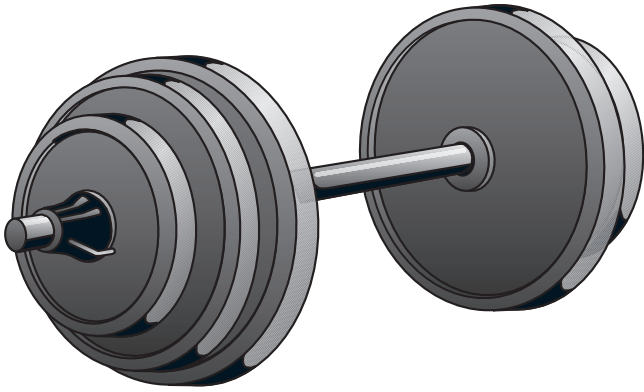

bloc

trom?

ciúb

éadrom?

a dó

níos troime?

dhá cheann

níos éadroime?

óg?

sean?

Cén aois?

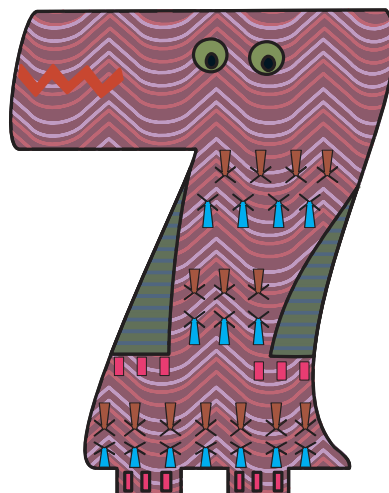
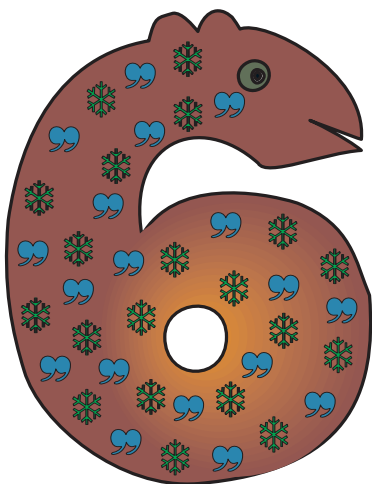
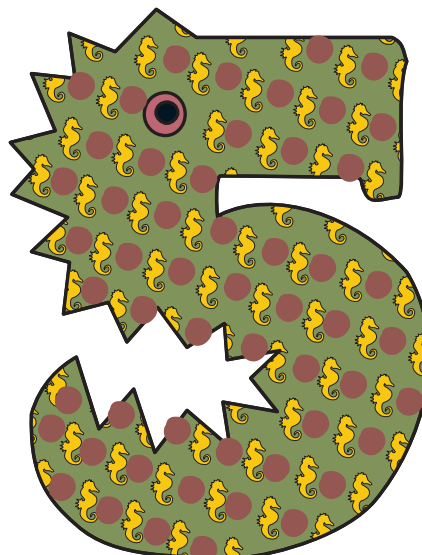
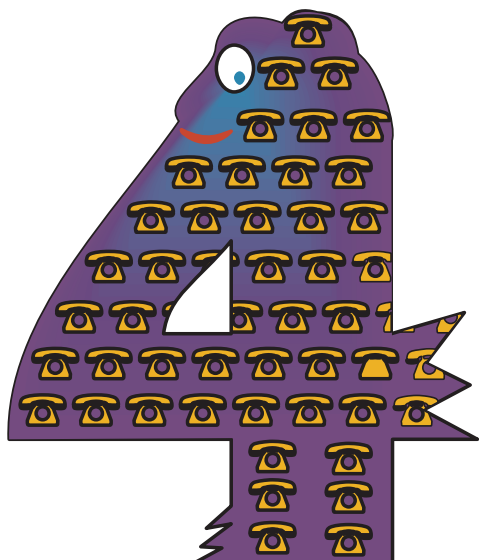

a trí

a dó

a cúig

a ceathair

a seacht

a sé

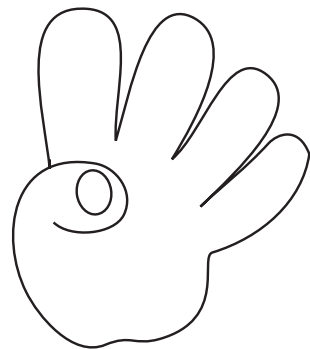
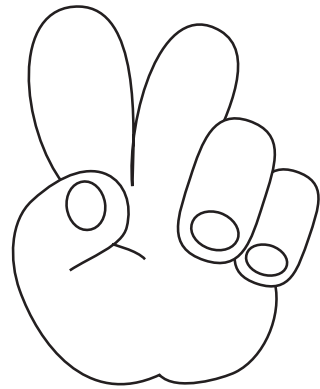
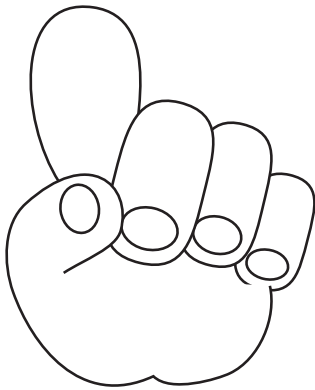
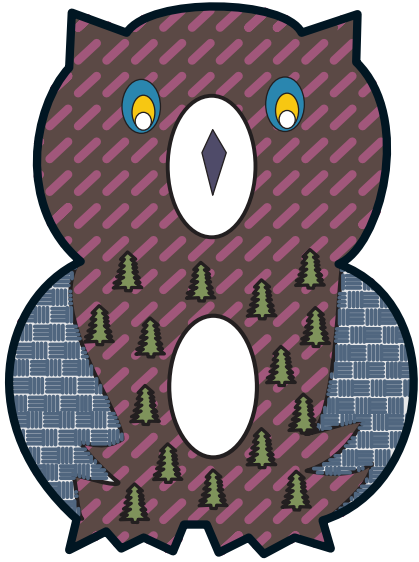

a naoi

a hocht

naoi gcinn

ocht gcinn

a dó

a haon

dhá cheann

ceann amháin

a ceathair

a trí

ceithre cinn

trí cinn

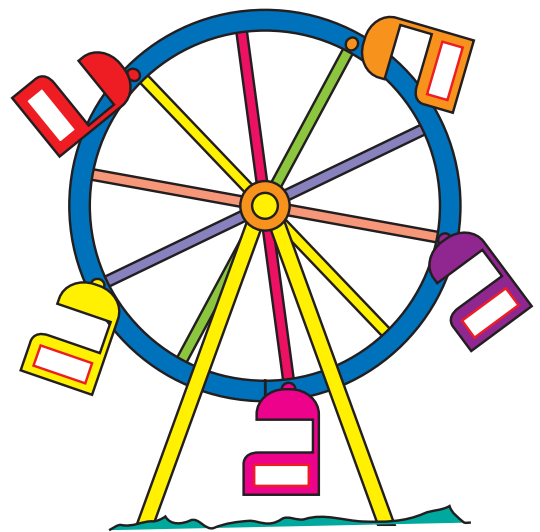
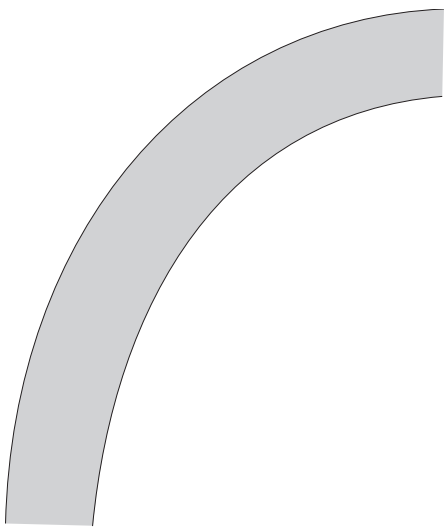
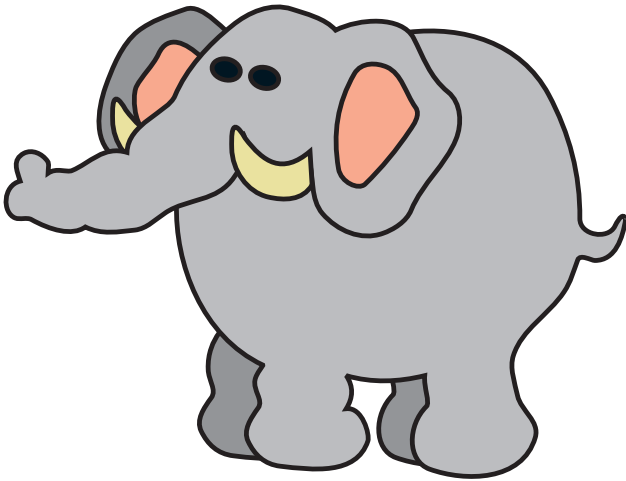
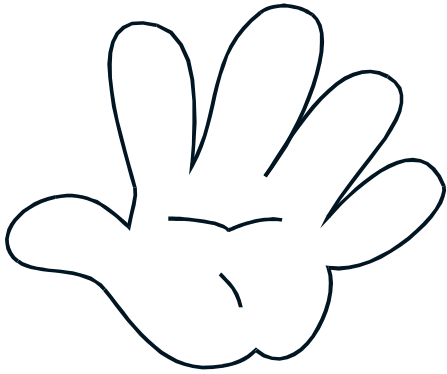

sean?

cúig

óg?

a cúig

mór?

mór?

beag?

beag?

timpeall

cuar

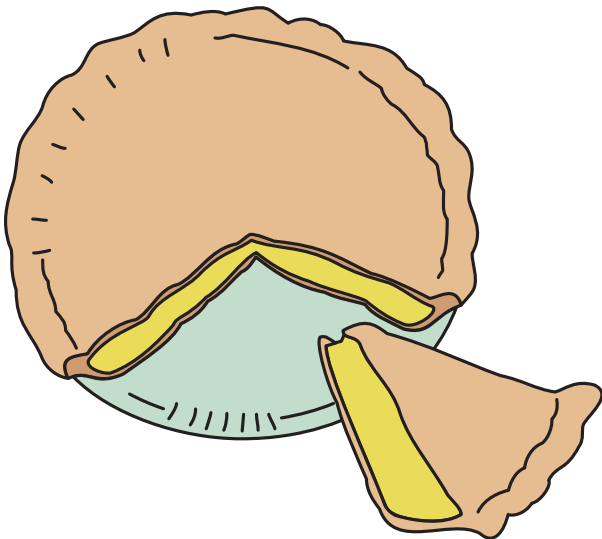

lá

isteach

oíche

píosa

cón

lán?

folamh?

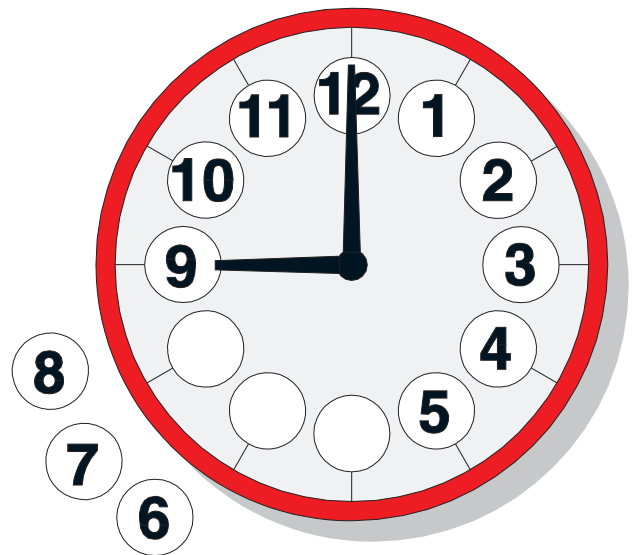
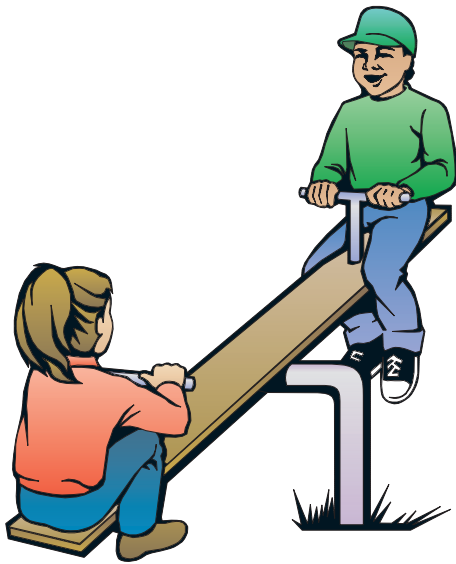
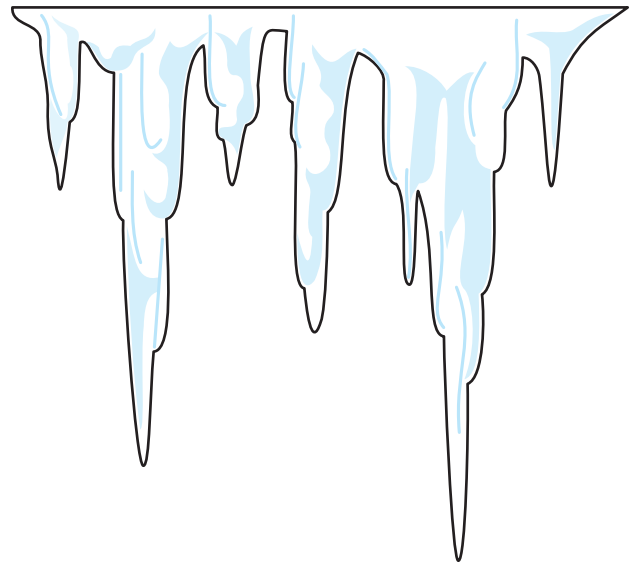

fuair

boinn

an clog

thuas?

thíos?

brúigh

anuas

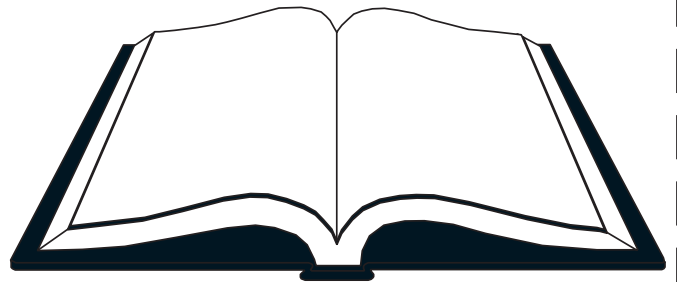
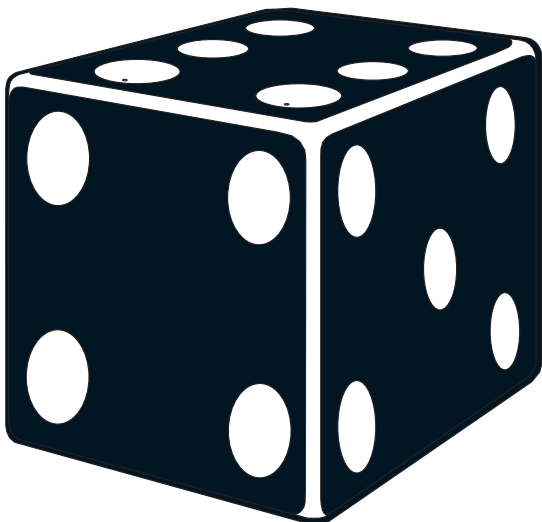
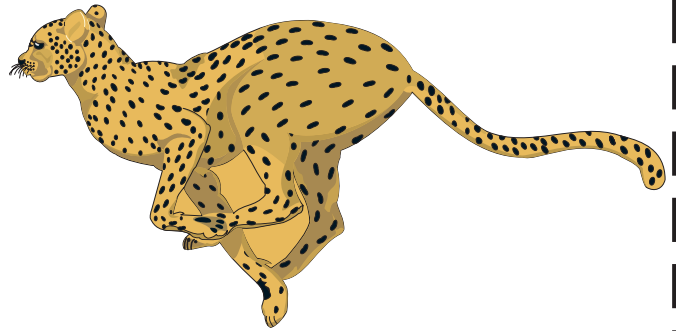
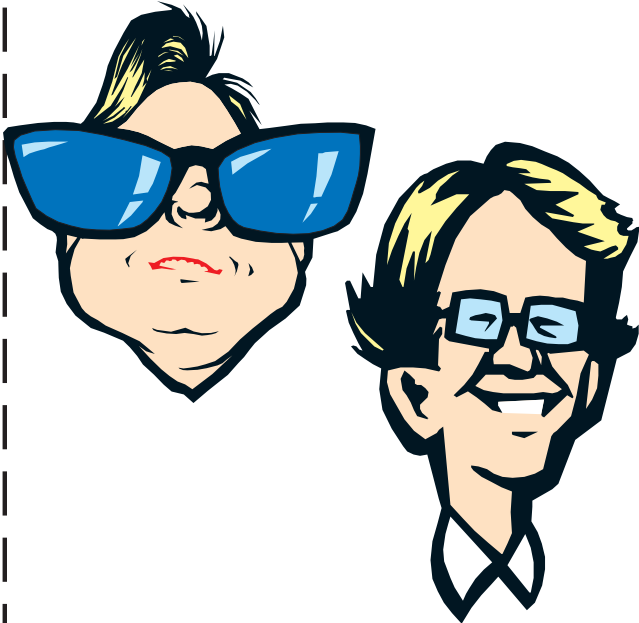
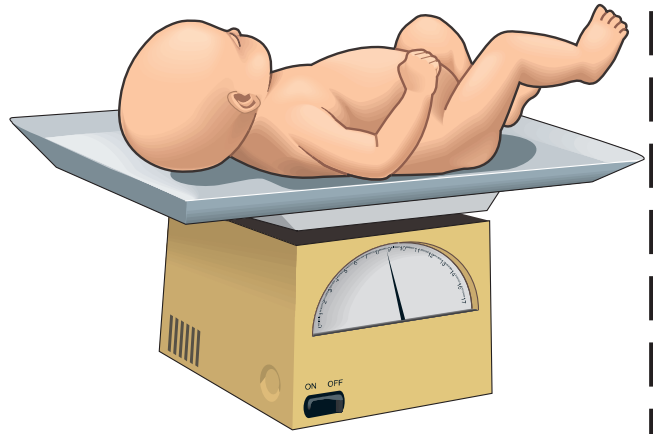

meáchan

suas

tapa

mór?

beag?

oscailte

ciúb

spotaí

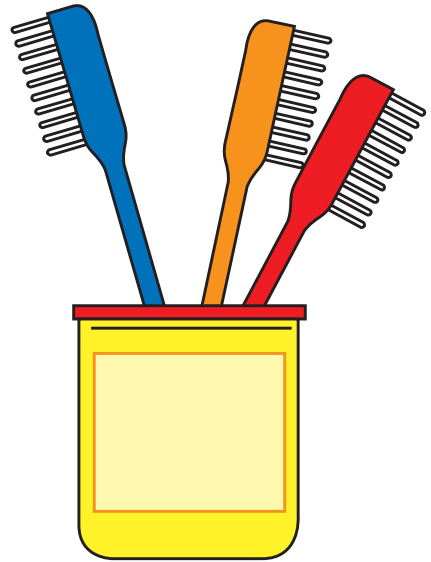

péire

dúnta

trí cinn

éadrom?

trom?

mall?

níos mó

tapa?

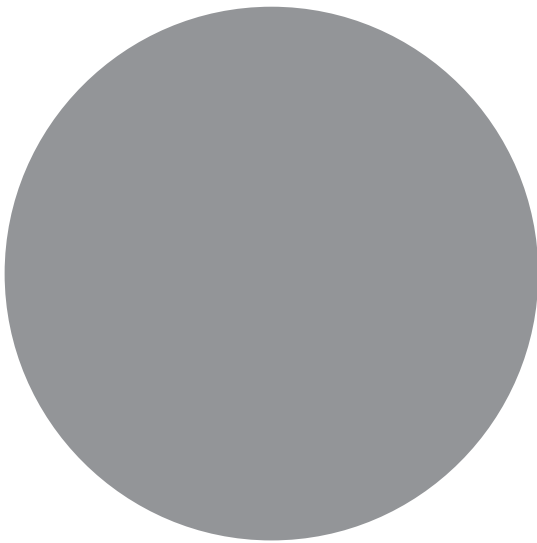
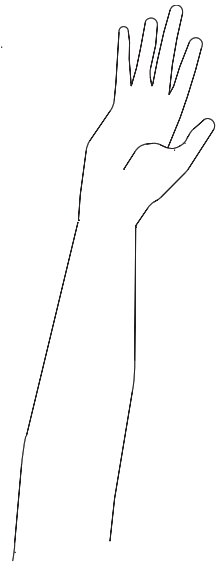
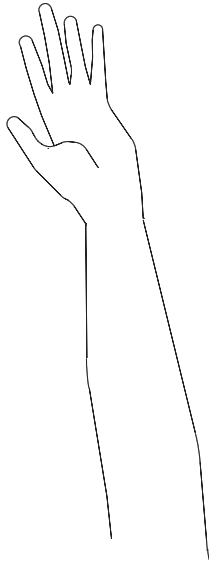

deas?

deas?

clé?

clé?

rollaigh

cearnóg

crua?

ciorcal

bog?

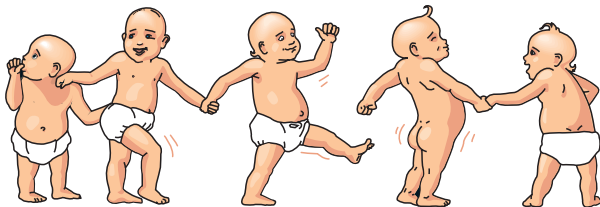
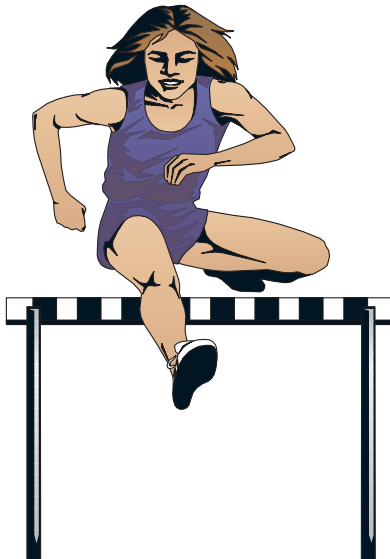
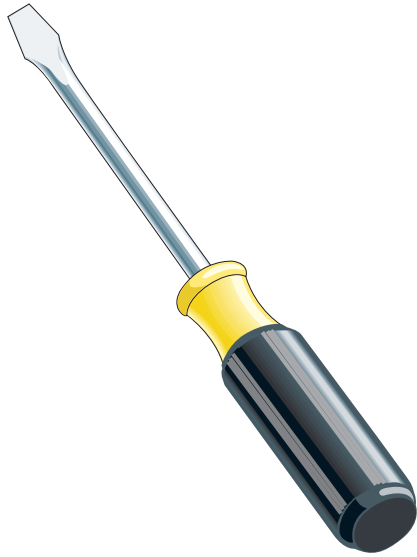

fána

cas

tosaigh

thar

tapa

cé mhéad?



péire

trí cinn

leath

lár

fáinne

ciúb

bog

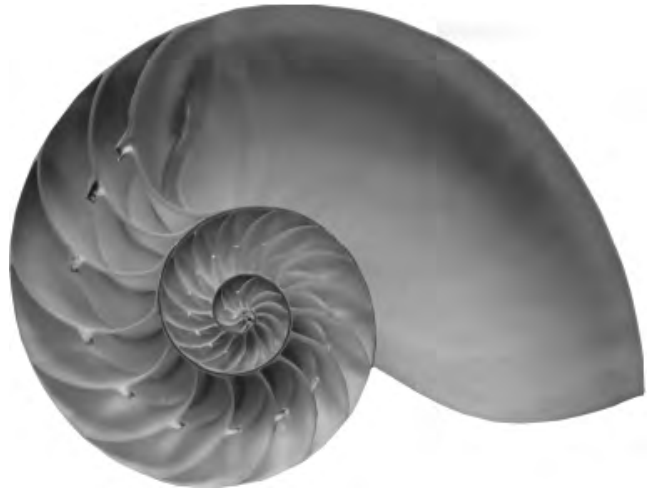

bís

deas?

clé?

tapa

deas?

clé?

cruinn

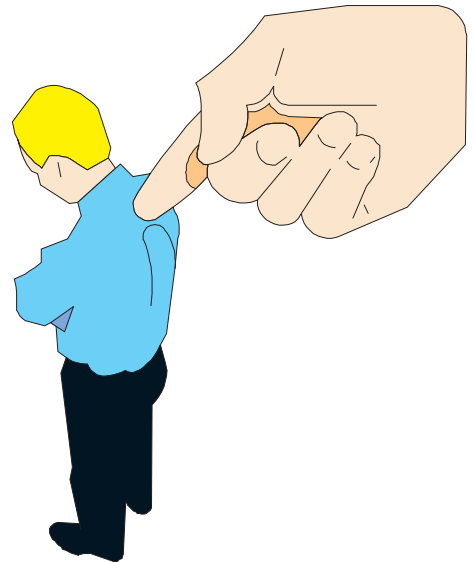
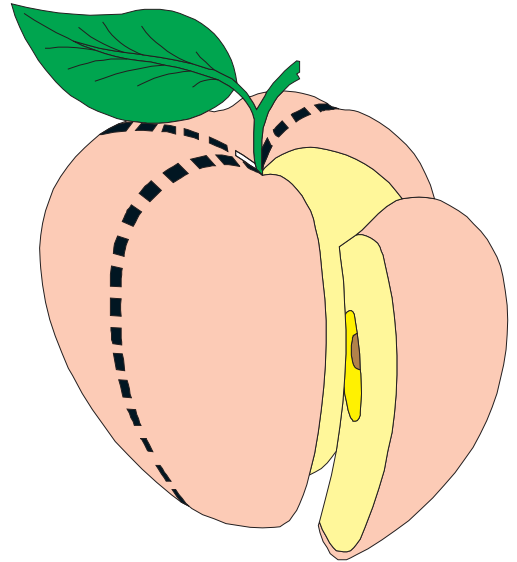
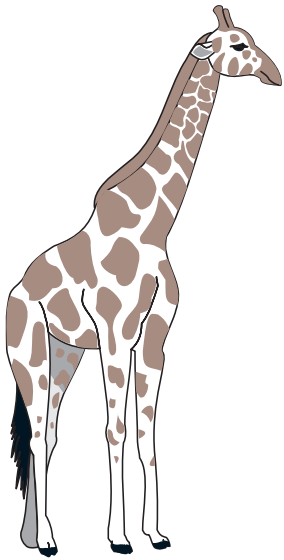

roinn

ard?

beag?

méar a
shíneadh

ceangail

péire

airde

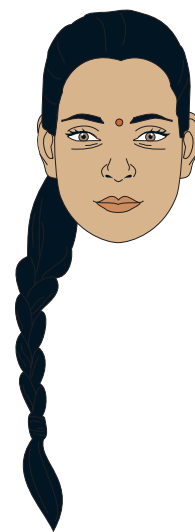
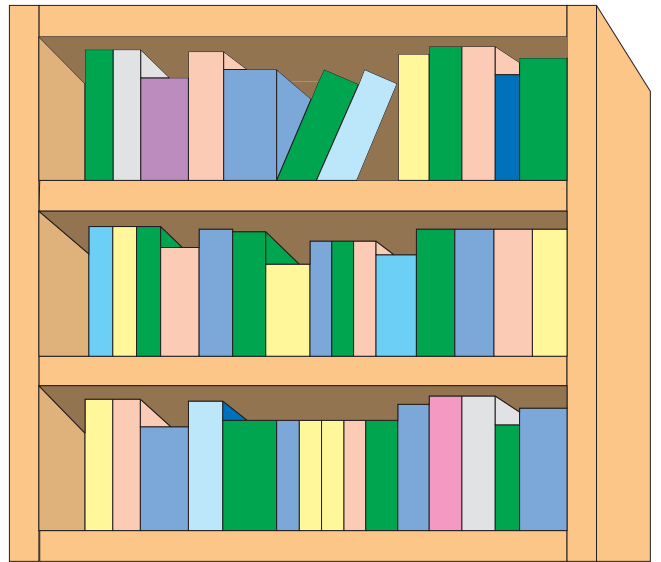
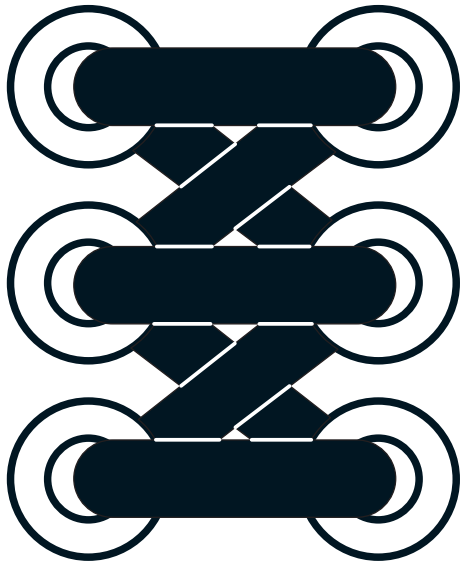

barr
lár
bun

fiarlán

folamh

cas

fada

thar

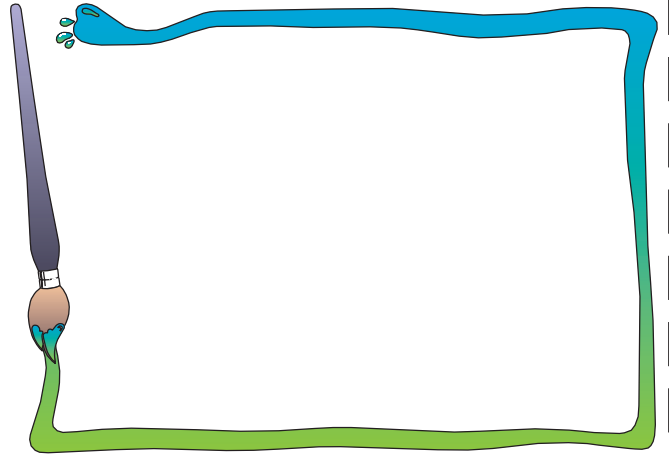
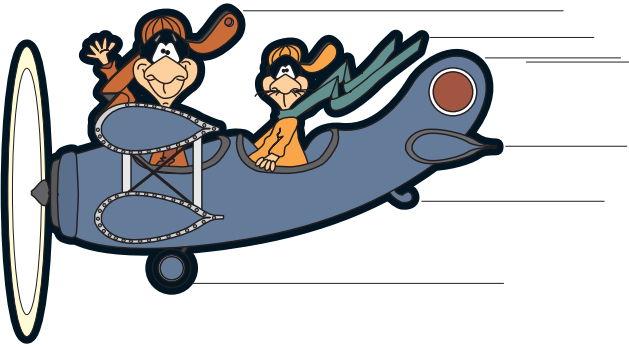
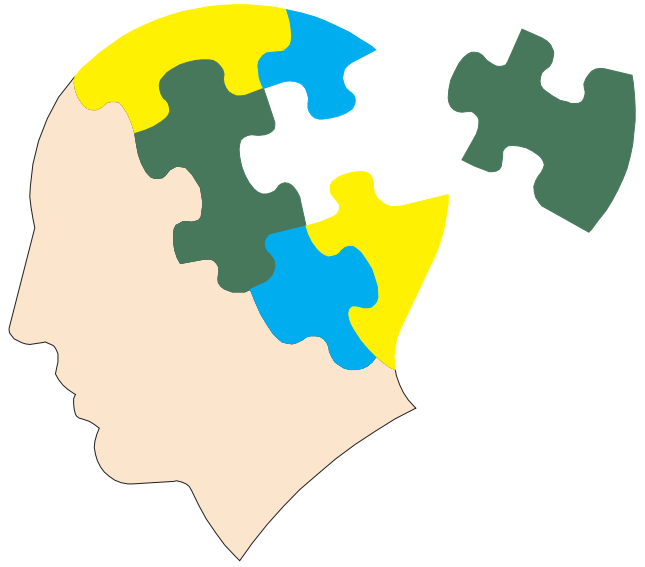
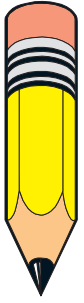

cuir le chéile

níos mó

níos lú

imeall

tapa

lúbtha

ramhar

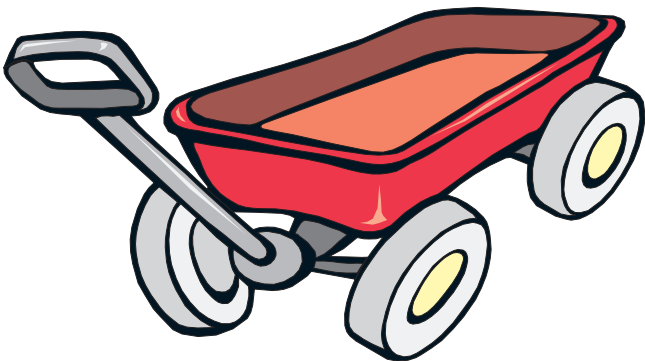
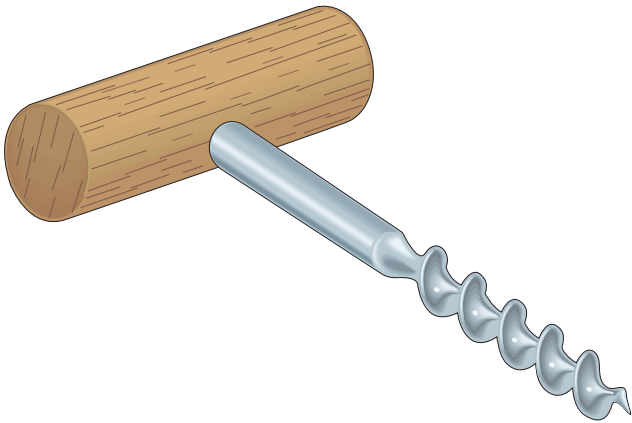

ar

barr

bun

isteach

cas

faoi

folamh



lán

cén aois?

sa chéad áit
sa dara háit
sa tríú háit
ar deireadh

bainte de

cúinne

cothromaíocht

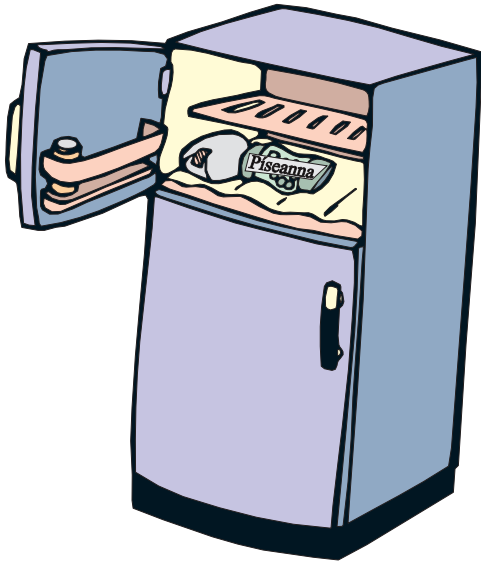
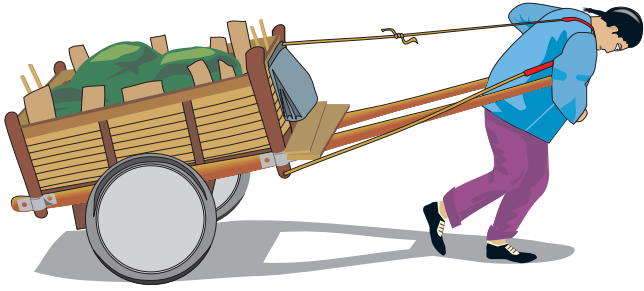

fuar?

tarraing

te?

fada?

te?

gearr?

fuar?

trom?

isteach

éadrom?

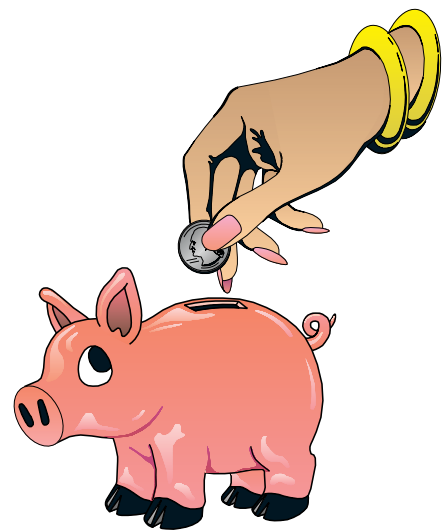
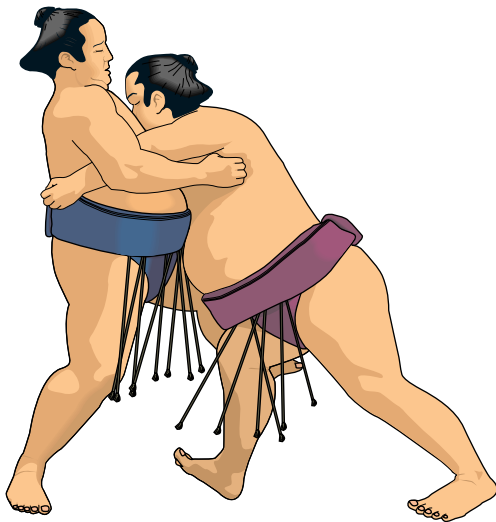

ar snámh

te?

fuair?

lá fuair?

cé mhéad?

lá te?

isteach

éadrom?

trom?

Eangach le haghaidh Ciúib

ciúb

Déan cóip den chruth seo ar leathanach cairtchláir.

